

NURSE CALL and HEALTHCARE BED ACCESSORIES





CURBELL MEDICAL

OUR LONG HISTORY

Curbell has been supplying hospitals and long-term care facilities with innovative products for over 50 years. We have strong relationships with bed, television, and nurse call system manufacturers, and we work closely with them to ensure that our products work properly and safely with all types of equipment. Most importantly, we work with you, to create custom solutions that meet your requirements and specifications.

NURSE CALL AND BED EXPERIENCE

From our beginning, Curbell has been involved in connecting hospital room equipment to various types of nurse call systems and beds. Since then, we've become an industry leader in patient room integration, and we use this expertise to make sure that our equipment properly interfaces with your nurse call system, no matter the brand, to keep patients and caregivers connected.

OUR COMMITMENT TO QUALITY

Curbell works to continuously improve our operations, products, and services. Our quality management system complies with ISO 13485:2016 (MDSAP), and we are compliant with all government and industry regulations. We are also medical device listed (FDA), and are a current Good Manufacturing Practices (cGMP) Compliant Facility.

CONTENTS

Quality and Regulatory Compliance	2
Customized Solutions	3

PATIENT COMMUNICATION DEVICES AND ACCESSORIES

Rēgo Patient Interaction Device	4-7
Gen4+ Pillow Speakers	8-10
Pillow Speaker Accessories	11
Gen4 Interactive and Smart TV Pillow Speakers	12-13
Pillow Speaker Breakaway Cables	14-15
Pillow Speaker Testers	16
Handheld Pendants	17
Remote Entertainment Station	18-19
Pillow Speaker Repair Service	20

CALL CORDS

Call Cord Solutions	21-24
Specialty Call Cords	25-28
Assistive Control Adaptor AC20	29-32

CABLES AND INSTALLATION PRODUCTS

Adaptors	33
Wall Plates	34
TV Jumper Cables	35
Dummy Plugs	36

BED COMMUNICATION CABLES

Bed Communication Cable Overview	37-38
Breakaway Bed Cables	39-41
Breakaway Bed-to-Nurse Call Cables	42-43
Breakaway Cable Locking Solutions	44-45
Standard Bed Communication Cables	46
Standard Bed-to-Nurse Call Cables	47
Receptacle Kits and 37-Pin Dummy Plugs	48

LIGHTING

Low Voltage Controllers	49-55
Low Voltage Controller Wall Switches	56

PRICE LISTINGS

Parts and Price Listings for Individual Nurse Call Systems	57-91
Other Product Lines	92
Ordering and Warranty Information	Back Inside Cover

Curbell is a registered trademark and service mark of Curbell Inc.

All other trademarks and service marks are property of the respective manufacturers as noted by the appropriate trademark notice throughout this catalog.

Prices are subject to change without notice.

QUALITY AND REGULATORY COMPLIANCE

Quality is much more than an adjective used to describe our products. For us, it's an entire system that guides the design and manufacture of those products. Our Quality and Regulatory team understands the procedures necessary for assuring compliance with all applicable healthcare industry standards and regulations so we can make sure that our nurse call accessories continue to meet all applicable standards. Consequently, nearly all of Curbell's nurse call accessories are UL Listed and all are tested directly with the intended nurse call systems and healthcare televisions to ensure the highest level of safety and regulatory compliance.

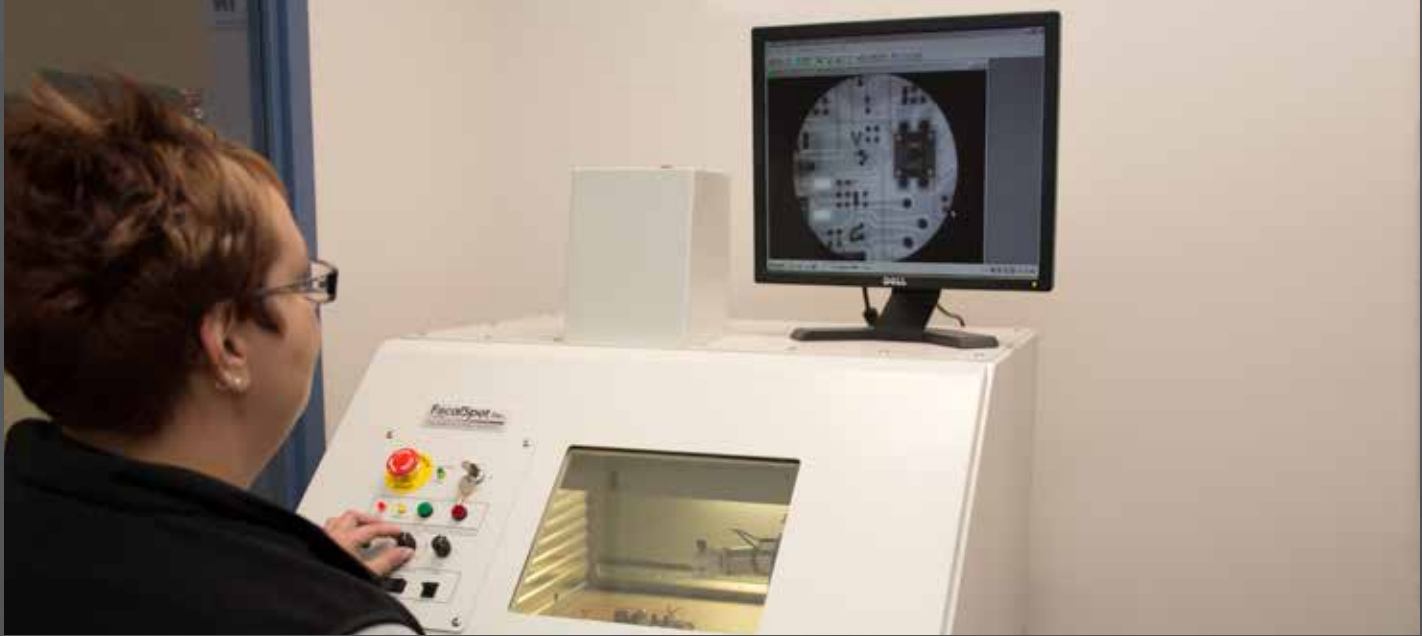

ISO 13485

This standard specifies requirements for a quality management system where an organization needs to demonstrate its ability to provide medical devices and related services that consistently meet customer and applicable regulatory requirements.

UL TESTING CAPABILITIES

In order to evaluate and certify products, UL uses product samples in their test processes. While UL maintains their own extensive test facilities, a select number of their customers (such as Curbell) qualify to utilize their own in-house test facilities and equipment under the supervision of UL personnel.

QSR COMPLIANCE

Specific to FDA Medical Devices, this refers to Quality System Regulation. A quality system is a necessary component of any medical device commercialization effort. For medical device manufacturers seeking regulatory clearance or approval in the US, 21 CFR Part 820 of US Code of Federal Regulations is necessary to meet quality system requirements (QSR) and bring their products to market.

MDSAP CERTIFICATION

Medical Device Single Audit Program (MDSAP) certification indicates that a company complies with the regulatory requirements for the markets defined in the certificate. For Curbell, this covers the US, Canada, and Australia.

INTERNATIONAL COMPLIANCE

- ▶ EU MDR (European Medical Device Regulations)
- ▶ MDR of Canada (Canadian Medical Device Regulations)
- ▶ RoHS (Restriction of Hazardous Substances) is a European directive on the restriction of the use of certain hazardous substances in electrical and electronic equipment. (i.e. lead, mercury, cadmium)
- ▶ REACH (Registration, Evaluation, Authorization, and Restriction of Chemicals) is a regulation of the European Union, adopted to improve the protection of human health and the environment from the risks that can be posed by chemicals.

C-TPAT

C-TPAT (Customs-Trade Partnership Against Terrorism) is a voluntary public-private sector partnership program which recognizes that US Customs and Border Protection can provide the highest level of cargo security only through close cooperation with the principle stakeholders of the international supply chain such as importers, carriers, consolidators, licensed customs brokers, and manufacturers.

CUSTOMIZED CONNECTION SOLUTIONS

Among the dozens of nurse call systems, televisions, interactive systems, and beds available, there are tens of thousands of configurations possible in any hospital room. Once you add in lighting options, wiring inconsistencies, and additional special features, it's easy to see that designing and specifying the products that enable communication between these systems requires a lot of expertise. Curbell Medical works closely with all the manufacturers of these systems to make sure that our products operate properly, and our knowledgeable staff can quickly help you select the right products to meet your specific requirements.

You can count on Curbell to keep you connected.

WE CONNECT BEDS TO NURSE CALL

No matter what type of bed and nurse call system you have, we have a cable to connect them. Multiple bed types and nurse call systems in your facility? No problem.

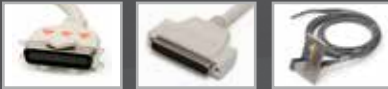

WE CONNECT PATIENTS TO LIGHTING

Our low voltage controllers are mounted in the wall or lighting fixture to let patients turn lights on and off, and even dim them.



WE CONNECT PATIENTS TO NURSING

No matter what type of nurse call system you have, we have a device that let's your patients communicate with a nurse — from a simple call cord, to our advanced Gen4+ Pillow Speaker, to our Rêgo Patient Interaction Device.



WE CONNECT FAMILY TO ENTERTAINMENT

Our Remote Entertainment Station gives family access to the same TV controls as the patient.



WE CONNECT PATIENTS TO ENTERTAINMENT

Our wall plates and jumper cables are the final point in the communication path from the pillow speaker to the TV.

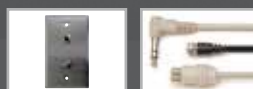

WE CONNECT STAFF TO LIGHTING

Our low voltage wall switches can be mounted anywhere in the room to give staff access to lighting without having to touch the pillow speaker.



RĒGO PATIENT INTERACTION SYSTEM

Empowering patients and clinicians

Patients are desiring greater connectivity and immediate access to information. As a result, some hospitals are providing commercial tablets to patients to enhance the hospital stay. These consumer tablets introduce challenges with connectivity, charging, device tracking and management, as well as data security.

The Rēgo™ Patient Interaction System is a scalable platform that addresses the challenges associated with tablets, integrating all patient controls into a single, medical-grade device. It's designed to meet patient and hospital requirements with a focus on enhanced communication, information access, security, durability, cleanability, and regulatory compliance.

NURSE CALL FUNCTIONALITY

Empowering patients starts with giving them the peace of mind knowing that they can quickly and easily call the nurse via your nurse call system, and with Rēgo, calling the nurse is just the beginning of what patients can do.



TV CONTROL

Patients control the TV with the dedicated channel, volume, mute, and power buttons, while pop-up screens provide control of additional television features.



CUSTOM INTERFACE AND APP STORE

Rēgo is customized for your facility. You pick what's on each screen and what apps you want to offer to your patients.



ROOM COMFORT CONTROL

Give your patients enhanced control of room lighting, shades, temperature, and more from the dedicated room control screen, customized to the room level.



RĒGO IS PURPOSE-BUILT FOR THE PATIENT ROOM



Rēgo is an Android™ device. Curbell is licensed for Google Mobile Services and certified as a Google Original Device Manufacturer.



Rēgo is a medical device per the FDA and meets all compliance requirements including UL 1069 and part 15 of the FCC rules.



Rēgo's display is a 7" diagonal touchscreen with a resolution of 1024 x 600 and is protected by Corning® Gorilla® Glass.



Designed to survive 100 drops from four feet onto a concrete floor and compatible with most common hospital cleaners and disinfectants.



Network security and patient privacy is paramount. You decide what apps to install, and wiping data between patients is quick and easy.



Bluetooth functionality provides the ability to connect Rēgo with up to 10 additional devices in the room.



Rēgo can connect to your hospital's network via WiFi or hardwired ethernet.



Rēgo includes a front facing camera for video chat. A 5 MP rear-facing camera with flash is optional.



INTERNET

With Rēgo's built in web browser, patients can access the internet to stay connected via social media, news, weather, etc.



VIDEO CHAT

Patients can connect via video chat with friends and family. Your hospital can even use the system to allow patients to communicate with doctors or a translation service.



EDUCATION

Give your patients access to documents and videos that help them better understand their condition and treatment.



INTERPRETATION

Leverage your existing interpretation service to be delivered via Rēgo in every patient room so it's always available when needed.



GAMES AND E-BOOKS

Games and electronic books can provide an alternative entertainment option for patients to help pass the time and reduce anxiety.



MUSIC AND RELAXATION

Patients can listen to music from various online sources through the built-in speakers, or via the headphone jack.



ELECTRONIC MEDICAL RECORDS

Leverage Rēgo to integrate with your existing EMR system to provide valuable information to patients and increase clinical efficiency for your staff.



PATIENT ENGAGEMENT SYSTEMS

Rēgo can integrate with your existing patient engagement system, giving patients touchscreen access to the system's features in addition to the TV.



All buttons are back-lit, making them easy to find in the dark. Additional LEDs give visual assurance of various functions.



The device is powered and tethered at all times. When not in use, it can be placed into the holder, which can mount to most bed side rails.



The same holder can be used as a stand to allow use on an over-bed table.

RĒGO INSTALLS IN MINUTES

Installation can be accomplished without room downtime and does not require access behind the wall.

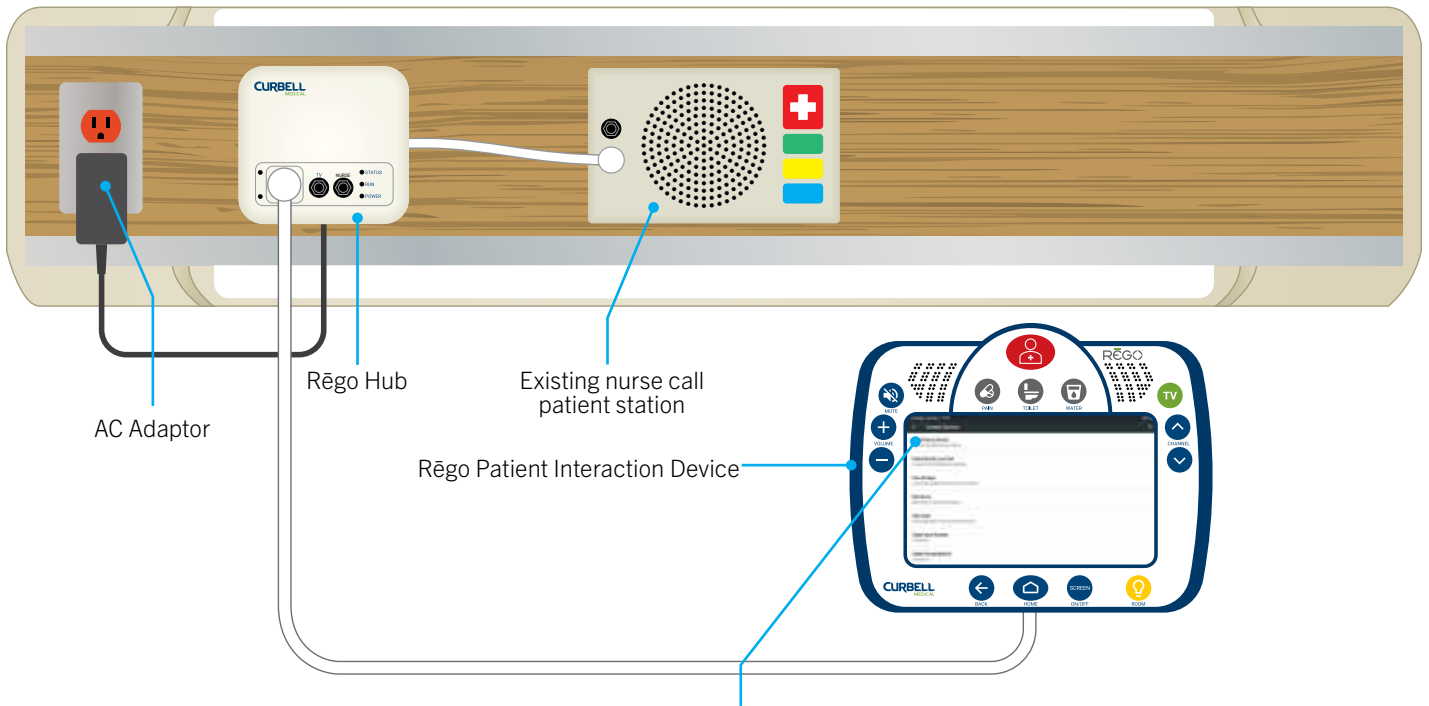

SETUP AND SECURITY

The Setup Wizard makes configuring the device simple. When a patient is discharged, all user data can be deleted, ensuring that anything entered into the device during the patient's stay is deleted.



THE RĒGO HUB

The Hub is a key component to the Rēgo system that performs several functions:

- ▣ Provides constant power to the Patient Interaction Device (PID) so it never needs charging
- ▣ Connects to your existing nurse call system
- ▣ Provides connections for additional hardwired room controls (lights, shades, etc.) to supplement what the nurse call station offers
- ▣ Provides an ethernet connection option in addition to the PID's built-in WiFi

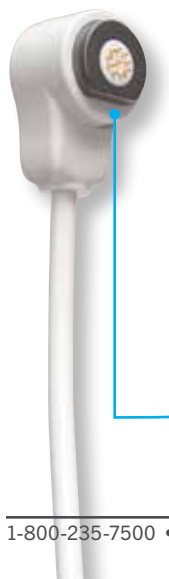

LEDs provide visual verification of system status

1/4" jacks accommodate specialty call devices

Rēgo's unique magnetic connector is designed for ease of use and reduces plug damage issues

GEN4+ PILLOW SPEAKERS

▶ NEW!

PUT YOUR PATIENTS IN CONTROL

Gen4+ Pillow Speakers feature new enhancements that give you the ability to provide your patients with a better experience in their room, and give them more control over a situation in which they might feel powerless. Knowing that patients aren't always at full strength when in the hospital, we've concentrated on making Gen4+ easy to use to give them more control of their environment with less effort.

▶ NURSE CALL

Whether they're in pain, want something to drink, or need to use the bathroom, Gen4+ makes calling the nurse easy.

▶ THE ROOM ENVIRONMENT

Gen4+ can be customized to work with the systems in your rooms to control lighting, temperature, window shades, and more.

▶ TELEVISION

With a clean layout and clear sound, Gen4+ makes it easy for patients to pass the time with their favorite TV show.



Gen4+

VISIBILITY (NEW FEATURE)

The high-contrast case color and graphics make it easy for patients to find and use

SPECIFIC NURSE CALL BUTTONS

Enable patients to relay their specific needs to the nursing staff

DURABLE

The high-impact case material is designed to withstand over 100 drops onto a concrete floor without affecting its functionality

FULLY SEALED

The sealed design reduces the potential risk of infectious fluids or solids settling into the unit — even in the speaker area.

EASIER-TO-PRESS BUTTONS (NEW FEATURE)

Large buttons are recognizable at a glance and easy to press



CURBELL
MEDICAL

CRISP, CLEAR SOUND

Clear, high quality sound to increase patient satisfaction

SOUND OPTIONS

Add a headphone jack to create a quieter environment and analog volume to ensure independent control in situations where two devices control one TV



ROOM CONTROLS

The Gen4+ platform allows for up to four buttons to control lighting, temperature, shades, etc.

DASH BUTTON (NEW FEATURE)

Allows patients to access digital subchannels

EASY TO CLEAN

The streamlined design facilitates quick and easy cleaning to aid in infection control

STRAIN RELIEF

The internal strain relief prevents damage to internal components

FLEX RELIEF

The long flex relief is designed for longer life and greater flexibility

GEN4+ PILLOW SPEAKER CUSTOMIZATION



GEN4+ GIVES YOU OPTIONS

When your hospital has specific requirements for pillow speakers, you can count on Curbell to customize them to get you exactly what you need.

With over 50 years of experience and literally thousands of different models to choose from, we'll work with you to meet all your unique needs to help you deliver the best patient experience possible.

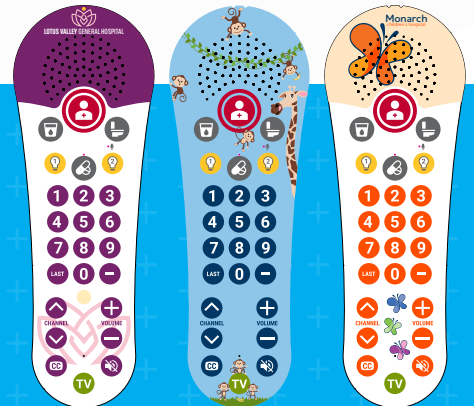

Gen4+ can be customized to promote your hospital's brand.

PILLOW SPEAKER HOLDERS



BEDSIDE HOLDER

- ▣ Fits over most side rails and puts the pillow speaker within easy reach of the patient
- ▣ Eliminates the need to wrap the pillow speaker cable around the bed rail, which can damage the cable
- ▣ All buttons are accessible by the patient for hands-free use



DESCRIPTION	MODEL NUMBER	PART NUMBER	PRICE
Pillow Speaker Holder	HLD-1000-001	22718	\$11.95



WALL HOLDER

Mounts directly to the wall to keep the pillow speaker secure when not in use.



DESCRIPTION	MODEL NUMBER	PART NUMBER	PRICE
White Pillow Speaker Holder	MSC-4023-004	14984	\$8.95
Beige Pillow Speaker Holder	MSC-4023-001	9598	\$8.95

SINGLE-USE HEADPHONES AND EAR BUDS

87% of hospitals recognize that they have a noise problem¹. If yours is one of them, you can minimize noise by using our lightweight and comfortable headphones or ear buds with a Gen4+ Pillow Speaker with an optional headphone jack. Patients will be more satisfied with their TV experience without being distracted by noise, and nearby patients and staff will benefit from a quieter environment.

DESCRIPTION	MODEL #	PART #	PRICE
Black stereo headphones	HP-030	7584	\$2.75
Black mono headphones	HP-050	7585	\$2.75
Black mono ear buds	HP-200	7586	\$1.75

NOTE: Cases of 100 available. Contact your sales representative for pricing.

1. www.theberylinsitute.org/resource/resmgr/webinar_pdf/final_-_noise_webinar.pdf





GEN4 FOR INTERACTIVE AND SMART TV

Helping keep your patients engaged

Curbell works with patient engagement system and Smart TV manufacturers to create Gen4 Pillow Speakers that are designed specifically for each system. Each pillow speaker gives you most features of our standard Gen4 Pillow Speaker, plus the ability to access and navigate through features specific to the patient engagement system or Smart TV, like on-screen menus and guides. Contact Curbell or your patient engagement system manufacturer for more information.

INTERACTIVE



Aceso



Allen Technologies



Cerner®



Evideon®



GetWellNetwork®



HCI



Lincor



OneView

INTERACTIVE



pCare



Skylight®



SONIFI



TeleHealth Services®

SMART TV



LG



PDi®



RCA



Samsung

DIGITAL INTERFACE BOX

Pillow speakers no longer communicate only with standard televisions. Today's technology presents ever-increasing demands for various additional integrations. The Curbell IBI has many potential applications, including the facilitation of an interface between pillow speakers and USB- or IP-driven hardware. The box is FCC-compliant and carries a UL Listing to hospital standards. Please contact Curbell with your customized application needs.

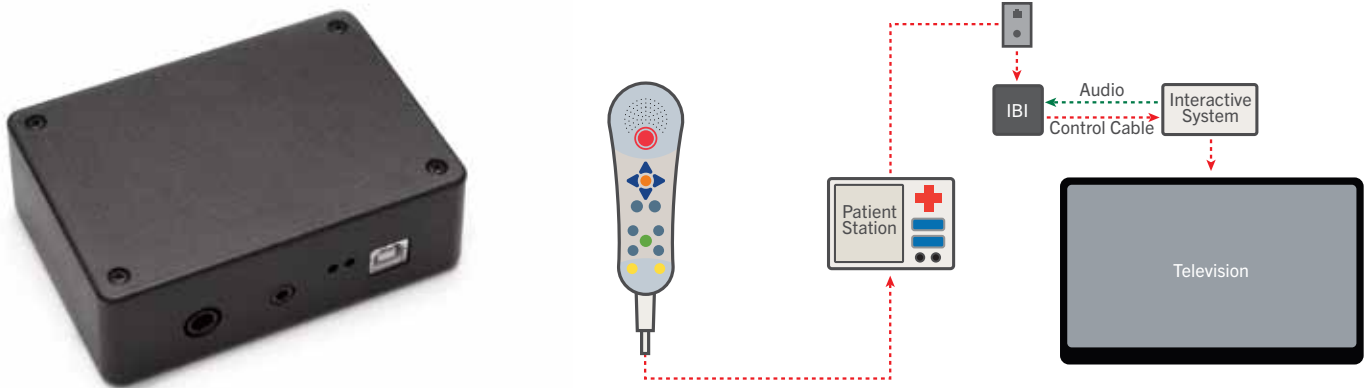

APPLE TV® SUPPORT

Apps and streaming services are the norm for today's entertainment. Much like smart TVs, tablets, and phones, Apple TV provides access to these services. Curbell's pillow speaker solution provides your patient control of Apple TV with a single device to navigate these offerings. The system consists of the custom pillow speaker and interface box, comprising the only healthcare grade solution for Apple TV on the market.



PILLOW SPEAKER BREAKAWAY CABLES

NEW!

REDUCE REPAIR COSTS





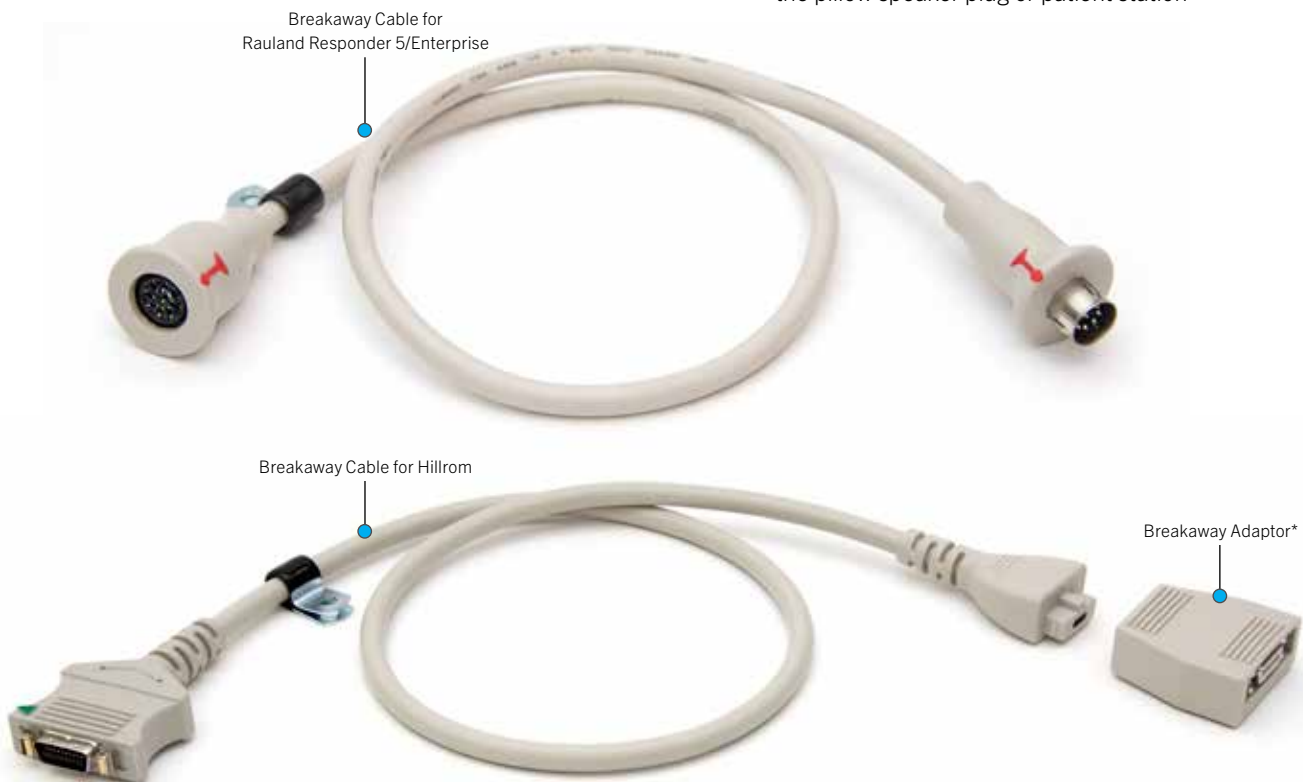
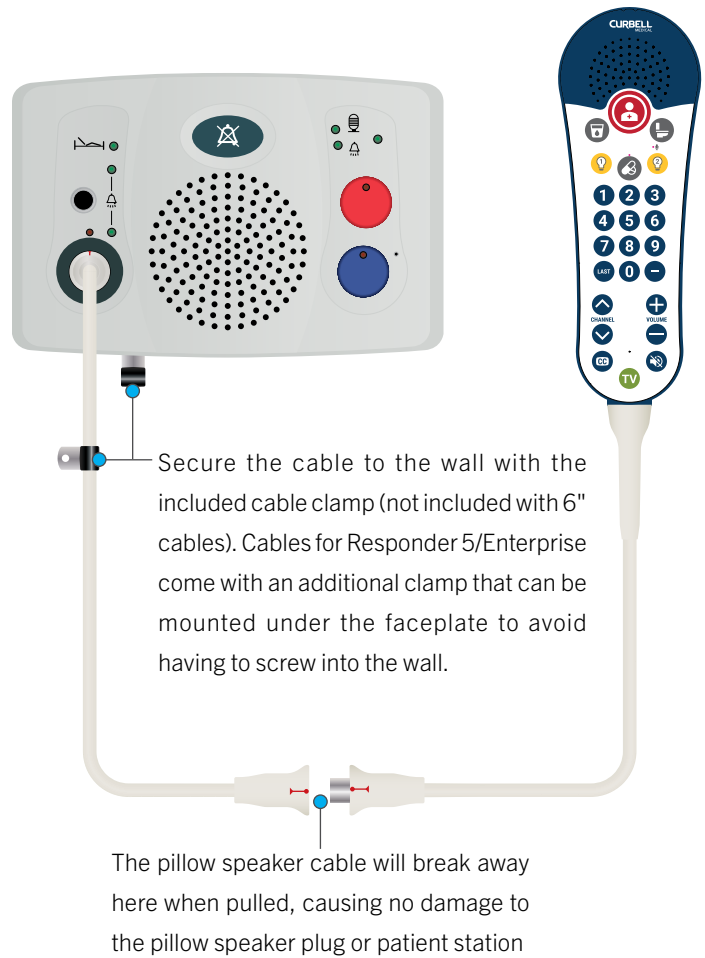







Pillow speakers need to hold up to the rigors of constant use by patients. To help reduce plug and patient station damage from excessive pulling, simply add a low cost Pillow Speaker Breakaway Cable which protects both by breaking apart cleanly when pulled in any direction.

- ▶ Designed to reduce the need for repair, not just make frequent cable replacements faster
- ▶ A small investment that can pay for itself in less than the cost of a single pillow speaker or patient station repair









* Replacement Hillrom Breakaway Adaptor available separately. Call Curbell for more information.

PILLOW SPEAKER BREAKAWAY CABLES

NURSE CALL SYSTEM	PILLOW SPEAKER PLUG END	LENGTH	MODEL	PART NUMBER	PRICE
Austco	 8-Pin DIN	8"	JUP-1901-008	15084	\$19.95
		24"	JUP-1901-024	20083	\$24.95
Critical Alert/Wescom/Intego SPS101, System 200, 1000/3000	 8-Pin DIN	10"	JUP-1065-010	26124	\$19.95
Hillrom COMposer, NaviCare	 20-Pin	24"	JUP-5335-200	25000	\$59.95
Intercall Legend II, Equinox II, Spectrum II, Ultra 6000, 6900, 9000	 8-Pin DIN	10"	JUP-1000-010-002	8482	\$18.95
		10" with 60° plug	JUP-1003-010-002	8489	\$18.95
		24"	JUP-1000-024-002	8483	\$19.95
		30"	JUP-1000-030-002	8484	\$20.95
Jeron Pro-Alert 640, Provider 680, Spectrum Pro IR	 8-Pin DIN	10"	JUP-1000-010-002	8482	\$18.95
		10" with 60° plug	JUP-1003-010-002	8489	\$18.95
		24"	JUP-1000-024-002	8483	\$19.95
		30"	JUP-1000-030-002	8484	\$20.95
Jeron Provider 680+, Provider 790	 8-Pin DIN (bell shape)	10"	JUP-1008-010-002	8492	21.95
Rauland Responder 5/Enterprise	 9-Pin DIN	24"	JUP-9000-2	8518	\$35.95
Rauland Responder 3+, 4, 4000, 5000	 8-Pin DIN	10"	JUP-1000-010-002	8482	\$18.95
		10" with 60° plug	JUP-1003-010-002	8489	\$18.95
		24"	JUP-1000-024-002	8483	\$19.95
		30"	JUP-1000-030-002	8484	\$20.95
TekTone Tek-CARE, NC300 II, Tek-CARE 400	 8-Pin DIN	10"	JUP-1000-010-002	8482	\$18.95
		24"	JUP-1000-024-002	8483	\$19.95
		30"	JUP-1000-030-002	8484	\$20.95
West-Com Odyssey, Odyssey Plus, Novus	 10-Pin Modular	6"	JU06-311	8124	\$18.95
		12"	JU12-200	8167	\$19.95
West-Com West-Call 1000, 8000, Endeavor, Marc II	 12-Pin	12"	JUP-1002-001	8488	\$25.95
		 8-Pin Modular	6"	JU06-311	8124
			12"	JU12-200	8167

PILLOW SPEAKER EXTENSION CABLES (FOR EXTENDING THE CABLE LENGTH OF PILLOW SPEAKERS)

NURSE CALL SYSTEM	PILLOW SPEAKER PLUG END	LENGTH	MODEL	PART NUMBER	PRICE
Intercall Legend II, Equinox II, Spectrum II, Ultra 6000, 6900, 9000	 8-Pin DIN	7'	JUP-1000-084-002	8485	\$24.95
		12'	JUP-1000-144-002	8486	\$34.95
Jeron Pro-Alert 640, Provider 680, Spectrum Pro IR	 8-Pin DIN	7'	JUP-1000-084-002	8485	\$24.95
		12'	JUP-1000-144-002	8486	\$24.95
Rauland Responder 5/Enterprise	 9-Pin DIN	5'	JUP-9000-5	21741	\$38.95
Rauland Responder 3+, 4, 4000, 5000	 8-Pin DIN	7'	JUP-1000-084-002	8485	\$24.95
		12'	JUP-1000-144-002	8486	\$34.95
TekTone Tek-CARE, NC300 II, Tek-CARE 400	 8-Pin DIN	7'	JUP-1000-084-002	8485	\$24.95
		12'	JUP-1000-144-002	8486	\$34.95
West-Com Odyssey, Odyssey Plus, Novus	 10-Pin Modular	6'	JU72-580	8426	\$23.95
West-Com West-Call 1000, 8000, Endeavor, Marc II	 8-Pin Modular	6'	JU72-580	8426	\$23.95

PILLOW SPEAKER TESTERS

CT-5 FOR RAULAND RESPONDER® 5/ENTERPRISE PILLOW SPEAKERS

The Curbell CT-5 tester is a portable unit designed to test any Curbell-manufactured pillow speakers compatible with the Rauland Responder 5 nurse call system. The CT-5 tester is to be used in conjunction with the included USB cable and a user-supplied desktop or laptop PC. It can test all Rauland Responder 5 Standard and Enhanced pillow speakers, as well as Curbell-manufactured “interactive” models compatible with the Rauland Responder 5/Enterprise systems.

Once connected to the tester and properly configured with a PC, you will be able to test the functionality of nurse call, nurse call workflow, environmental control auxiliaries, entertainment, call assurance, as well as speaker and microphone features.

- ▶ Quickly confirms functionality of buttons, LEDs, speaker, and microphone
- ▶ Powered by the USB connection on the computer (no batteries or wall connection required)
- ▶ Automatic recognition of pillow speaker type
- ▶ Colorful graphical user interface indicates the unit being tested
- ▶ Visual and audio confirmation of working buttons
- ▶ Hardware and software included
- ▶ For use with Windows XP, 7, 8, or 10



The included software shows which pillow speaker functions are being tested

CT-300

The Curbell CT-300 Tester is a portable unit that allows you to test Curbell DirectAccess and DPS pillow speakers*, call cords, Stryker® bed side rails, and Hillrom® analog SideCom™ bed side rails. The CT-300 interfaces to virtually any Curbell pillow speaker through interchangeable modules, and will test nurse call on all pillow speaker models and TV entertainment and auxiliary functions on most pillow speakers.

- ▶ Small, compact, and portable
- ▶ LCD display screen prompts for easy use
- ▶ Battery operated, AC adaptor included
- ▶ Order multiple adaptors for testing all equipment

* except pillow speakers for interactive systems



HANDHELD PENDANTS



STANDARD HANDHELD PENDANT

Curbell's handheld nurse call pendants are perfect for areas where footwall TVs or sound aren't necessary, such as areas with swing-arm televisions, or emergency rooms and intensive care units that don't have televisions.

- ▣ Large, colorful buttons are easy for patients to operate
- ▣ Overlay and switches can be tailored to your hospital's needs
- ▣ Can support up to four auxiliary functions
- ▣ Safe for use in oxygen environments
- ▣ Electrostatic Discharge (ESD) resistant design
- ▣ Self-extinguishing case material
- ▣ Repairable

SEALED HANDHELD PENDANT

The Gen4 Sealed Handheld Pendant brings the nurse call pendant into the 21st century, with its comfortable design, and industry-leading infection control and safety features.

- ▣ Proprietary sealed design (to IP67) keeps infectious contaminants out of the pendant
- ▣ Smooth shape and minimal crevices allow for easy, comprehensive cleaning, and reduce the potential for cross-contamination
- ▣ Modern, comfortable, ergonomic design fits naturally in the hand
- ▣ Large Nurse button is easy for patients to locate and operate
- ▣ Call assurance LEDs available for supporting systems
- ▣ Customizable auxiliary buttons
- ▣ UL Listing involves testing with the nurse call system to verify for safe use in an oxygen-enriched atmosphere

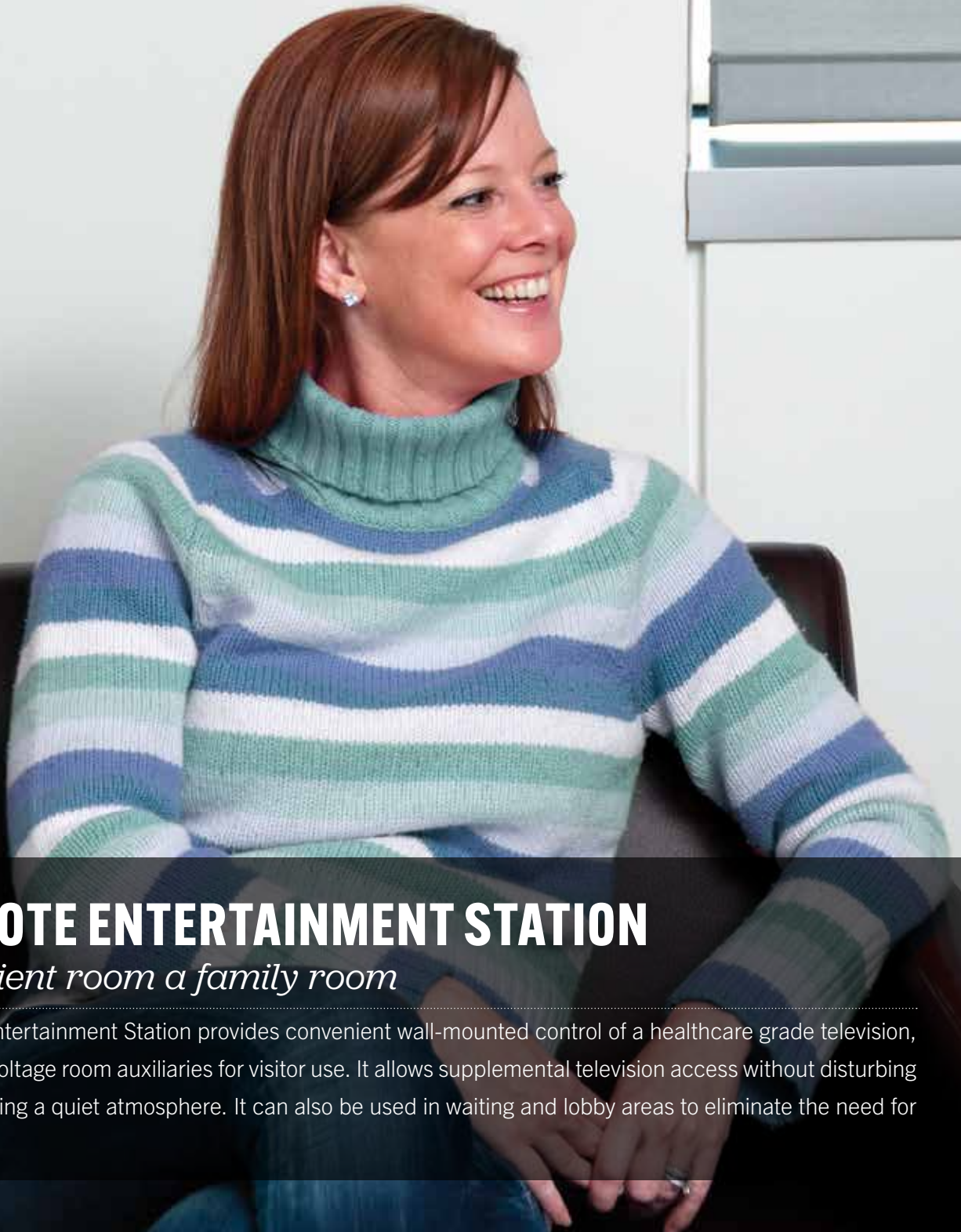

THE REMOTE ENTERTAINMENT STATION

Make a patient room a family room

Curbell's Remote Entertainment Station provides convenient wall-mounted control of a healthcare grade television, and up to four low-voltage room auxiliaries for visitor use. It allows supplemental television access without disturbing the patient, preserving a quiet atmosphere. It can also be used in waiting and lobby areas to eliminate the need for remote controls.

REMOTE ENTERTAINMENT STATION

FOR USE BY FAMILY MEMBERS IN PATIENT ROOMS AND WAITING AREAS



- ▣ Creates a visitor-friendly, home-like environment
- ▣ The Remote Entertainment Station is easily reprogrammed for any healthcare grade television
- ▣ Allows control of up to four room auxiliaries such as lighting, temperature, and drapes
- ▣ Two headphone jacks are ideal for creating a quieter environment
- ▣ Easy to install and repair
- ▣ Two year warranty

SPECIFICATIONS

Case	High impact plastic (ABS), UL flammability rating 94V-0
Dimensions	8.5" W x 5" H x 1.25" D
Mounting	Mounts to a two gang masonry box
Switches	SPDT momentary contacts for connection to power-limited circuits of 30 V DC, 500 mA or less
Wiring	Cable harness included

! SEE ADDITIONAL LIGHT SWITCHES ON PAGE 56



The Remote Entertainment Station provides easy access to the same TV features as a pillow speaker.



Visitors can watch television in the hospital room without disturbing the patient.



In waiting rooms, audio is brought to the seating area, helping to create a quieter atmosphere.

PILLOW SPEAKER REPAIR SERVICE



Curbell's highly trained repair team has the expertise to troubleshoot equipment malfunctions, provide timely repair, and keep your patient rooms connected. Save time and money by sending Curbell your damaged or malfunctioning pillow speakers. If you'd like to repair your pillow speakers yourself, see page 91 for parts and prices.

- ▶ Quick turnaround
- ▶ Repair available for most brands and models
- ▶ 90-day limited warranty against defects in materials and workmanship



1 Call Curbell for an RMA number, then ship the product to us.



2 The product is received in and routed to the correct repair station.



3 The product is cleaned inside and out.



4 The product is refurbished to original specifications.



5 The product is 100% tested.



6 The product is shipped back to you with a new 90 day warranty.



CALL CORDS

A simple solution









Call cords may be the simplest type of nurse call device, but they're often the best choice for areas without TVs, or for situations where a patient has special needs. Curbell's wide range of standard and specialty call cord options lets you handle any situation.

CHOOSING A CALL CORD



WHICH TYPE OF CALL CORD IS RIGHT FOR YOU?

Curbell offers seven types of call cords to meet the needs of your facility and your patients. You can learn more about those options on the next six pages. If you need more help determining what solution is right for you and your situation, call your Curbell sales representative at 1-800-235-7500.

	 Gen4 Sealed Call Cord (page 23)	 Classic Call Cord (page 24)	 Breathcall® (page 26)	 E-Z Call™ (page 26)	 Mechanical Pad (page 27)	 Padcall® (page 28)	 Presscall® (page 28)	 Assistive Control Adaptor (page 30)
You need a simple nurse call device	●	●	●	●	●	●	●	
You need the device to be oxygen Safe	●	●	●		●	●	●	
Easy cleaning	●				●			
The patient has limited dexterity			●	●	●	●	●	●
The patient has limited mobility			●	●				●
The device needs to control Nurse Call and TV			●				●	●
You would like an air-activated switch			●			●	●	
Your nurse call system requires a normally closed switch		●	●	●		●	●	
Full control of nurse call, lights, and TV								●

GEN4 SEALED CALL CORDS



The Gen4 Sealed Call Cord brings the call cord into the 21st century, with its comfortable design, and industry-leading infection control and safety features.

INFECTION CONTROL

- Proprietary sealed design (to IEC IPX7) keeps infectious contaminants out of the pendant
- Smooth shape and minimal crevices allow for easy, comprehensive cleaning, and reduce the potential for cross-contamination

PATIENT SATISFACTION

- Modern, comfortable, ergonomic design fits naturally in the hand
- Large button is easy for patients to locate and operate
- Call assurance LEDs available for supporting systems

OXYGEN SAFETY

- UL Listing involves testing with the nurse call system to verify for safe use in an oxygen-enriched atmosphere

PLUG TYPE	NURSE CALL SYSTEM	DESCRIPTION	MODEL NUMBER	PART NUMBER	PRICE
1/4"	Universal	8 ft.	SCC-0101-080-N	13259	\$17.20
1/4"	Universal	12 ft.	SCC-0101-120-N	13261	\$19.20
18-pin	Ascom/GE, Dukane	8 ft.	SCC-3701-820-U	13281	\$43.20
8-pin DIN	Jeron Provider 680	8 ft.	SCC-1901-081-U	13268	\$27.20
8-pin DIN	Jeron Provider 680+	10 ft.	SCC-4201-101-U	13286	\$30.20
8-pin DIN	Rauland Responder 4, 5000	8 ft.	SCC-1901-080-U	13266	\$27.20
9-pin DIN	Rauland Responder 5/Enterprise	10 ft.	SCC-4101-100-U	13285	\$34.20
8-pin DIN	Tektone Tek-CARE 400	8 ft.	SCC-1901-082-U	13269	\$27.20
15-pin	SimplexGrinnell EZCare	8 ft.	SCC-2908	13277	\$47.20
8-pin Modular	Critical Alert, Intego, TekTone, Wescom, West-Com	8 ft.	SCC-2101-080-U	13273	\$22.20
10-pin Modular	West-Com	8 ft.	SCC-2402-080-U	13276	\$25.20

CLASSIC CALL CORDS

Our Classic Call Cords are designed to meet your facility's wiring requirements, and are safe for use in oxygen-enriched environments.

- ▣ Large contoured button is easy for patients to operate
- ▣ Button provides tactile feedback with an audible click
- ▣ Custom cable lengths available
- ▣ Switch rated for minimum of 30,000 cycles per UL 1069 section 24
- ▣ Electrostatic Discharge (ESD) resistant design
- ▣ Self-extinguishing material



PLUG TYPE	NURSE CALL SYSTEM	DESCRIPTION	MODEL NUMBER	PART NUMBER	PRICE
 1/4"	Universal	12 ft.	CC144-010	5733	\$16.95
 1/4"	Universal	12 ft., dual	CC144-090	5740	\$36.95
 1/4"	Universal	8 ft.	CC96-010	5822	\$14.95
 1/4"	Universal	8 ft., coiled	CC96-210	5847	\$23.95
 1/4"	Universal	8 ft., dual	CC96-180	5843	\$32.95
 1/4"	Universal	8 ft., inline	CC96-045	5829	\$14.95
 1/4"	Universal	8 ft., normally closed	CC96-020	5823	\$14.95
 18-pin	Ascom/GE Telligence, Dukane	12 ft.	CC144-112	5742	\$44.95
 8-pin DIN	Intercall	8 ft.	CC96-200	5845	\$24.95
 8-pin DIN	Jeron Provider 680	8 ft.	CC96-300	5851	\$24.95
 8-pin DIN	Jeron Provider 620	8 ft.	CC96-315	5852	\$25.95
 8-pin DIN	Rauland	8 ft.	CC96-750	5860	\$24.95
 15-pin	SimplexGrinnell EZCare	8 ft.	CC96-983	5874	\$46.95
 8-pin DIN	Tektone Tek-Care 400	8 ft.	CC96-970	5871	\$24.95
 8-pin Modular	Critical Alert, West-Com, Intego	8 ft.	CC96-080	5835	\$19.95
 9-pin	Zettler Sentinel 400	8 ft.	CC96-347	5854	\$30.95
 9-pin	Zettler Sentinel 500	8 ft., normally closed	CC96-740	5859	\$30.95
 6-pin	Zettler Zetcom	8 ft.	CC96-050	5830	\$32.95



SPECIALTY CALL CORDS

Ease of use for those with special needs





Our specialty call cords have ultra-sensitive touch surfaces that are ideal for patients with limited manual dexterity, and they can be used with most nurse call systems.

SPECIALTY CALL CORDS

BREATHCALL®

- ▶ Pneumatic device activated by the patient's breath
- ▶ Single and dual models available
- ▶ For patients with special needs (severe burns, paraplegics, quadriplegics, immobilized patients)
- ▶ Adjustable clamp fits side rail or headboard
- ▶ Arm can be adjusted to almost any position
- ▶ Additional straws and filters available
- ▶ BreathCall is designated as a single-patient-use device for infection control





PLUG TYPE		NURSE CALL SYSTEM	DESCRIPTION	MODEL NUMBER	PART NUMBER	PRICE
	1/4" plug	Universal	9'	GEB-010	7380	\$143.12
	8-pin DIN	Rauland	9'	GEB-150	7387	\$173.42
	9-pin	Zettler Sentinel 500	9', normally closed	GEB-195	7394	\$184.95
	two 1/4" plugs	Universal	9', Dual (TV, Nurse)	GEB-200	7395	\$219.40
	NA	NA	12 Straws/Gray Filters	GEB-290	7396	\$45.93

BreathCall devices are available for many other systems. Call your Curbell representative for more information.

E-Z CALL™

- ▶ Can be placed anywhere for activation including the cheek, foot, hand, etc.
- ▶ Large tented design makes it easy for patient to see
- ▶ Linen clip securely attaches to bedding
- ▶ Velcro strip included for side rail mounting

















PLUG TYPE		NURSE CALL SYSTEM	DESCRIPTION	MODEL NUMBER	PART NUMBER	PRICE
	1/4" plug	Universal	10'	GEE-010	7402	\$69.95
	1/4" plug	Universal	10', normally closed	GEE-090	7403	\$69.95



MECHANICAL PAD

- ▶ Perfect for patients who may have difficulty using standard call cords or pillow speakers
- ▶ Large sensitive surface area
- ▶ Activates from any point on the pad's surface
- ▶ Linen clip securely attaches to bedding



PLUG TYPE	NURSE CALL SYSTEM	DESCRIPTION	MODEL NUMBER	PART NUMBER	PRICE
 1/4" plug	Universal	10'	GEM-0000-AGY	7407	\$43.95
 15-pin	SimplexGrinnell EZCare	10'	GEM-478	7434	\$49.95
 18-pin	Ascom/GE, Dukane	10'	GEM-477	7433	\$52.95
 20-pin	Cornell, Sylvania	10'	GEM-472	7431	\$48.95
 37-pin	Universal	10'	GEM-150	7420	\$57.95
 6-pin	Zettler Zetcom	10'	GEM-479	19854	\$63.95
 8-pin DIN	Jeron Provider 680	8'	GEM-180	7423	\$47.95
 8-pin DIN	Rauland Responder 4, 5000	8'	GEM-18	7422	\$47.95
 8-pin DIN	Jeron Provider 620	8'	GEM-240	7424	\$47.95
 8-pin DIN	Intercall	10'	GEM-300	7425	\$47.95
 8-pin DIN	TekTone Tek-CARE 400	10'	GEM-476	7432	\$47.95
 8-pin Modular	Critical Alert, Intego, TekTone, Wescom, West-Com	10'	GEM-471	7430	\$47.95
 9-pin	Zettler Sentinel 400	10'	GEM-160	7421	\$59.95
 10-pin Modular	West-Com	8'	GEM-480	15014	\$47.95

SPECIALTY CALL CORDS

PADCALL®

- ▣ Large call surface (3" diameter)
- ▣ Sensitive, air-activated switch
- ▣ Gripper feet hold pendant in place
- ▣ Linen clip securely attaches to bedding
- ▣ Custom lengths available



PLUG TYPE	NURSE CALL SYSTEM	DESCRIPTION	MODEL NUMBER	PART NUMBER	PRICE
1/4" plug	Universal	8'	GEA-030	7351	\$53.25
15-pin	SimplexGrinnell EZCare	8'	GEA-360	7379	\$151.48
9-pin	Zettler Sentinel 500	8', normally closed	GEA-195	7371	\$92.96
8-pin Modular	Critical Alert, Intego, TekTone, Wescom, West-Com	8'	GEA-145	7364	\$76.24
8-pin DIN	Intercall	8'	GEA-138	7361	\$76.24
8-pin DIN	Jeron Provder 680	8'	GEA-135	7359	\$76.24
8-pin DIN	Jeron Provider 620	8'	GEA-135R	7360	\$78.33
8-pin DIN	Rauland	8'	GEA-130	7357	\$76.24
8-pin DIN	TekTone	8'	GEA-139	7362	\$76.24
10-pin Modular	West-Com	8'	GEA-146	7365	\$87.73

PRESSCALL®

- ▣ Air activated
- ▣ Fits comfortably in patient's palm
- ▣ Available in dual and single styles
- ▣ Linen clip securely attaches to bedding
- ▣ Custom lengths available



PLUG TYPE	NURSE CALL SYSTEM	DESCRIPTION	MODEL NUMBER	PART NUMBER	PRICE
1/4" plug	Universal	8'	GEP-140	7441	\$41.75
1/4" plug	Universal	8', Dual TV, Nurse	GEP-300	7452	\$134.76
1/4" plug	Universal	8', Dual Nurse	GEP-210	7445	\$77.28
15-pin	SimplexGrinnell EZCare	8'	GEP-670	7472	\$143.12
8-pin DIN	Intercall	12'	GEP-262	7449	\$71.01
8-pin DIN	Jeron	8'	GEP-265	7450	\$64.74
8-pin DIN	Jeron Provider 620	10'	GEP-395	7457	\$71.01
8-pin DIN	Rauland	8'	GEP-260	7447	\$64.74
8-pin DIN	TekTone	8'	GEP-660	7471	\$64.74
8-pin Modular	Critical Alert, Intego, TekTone, Wescom, West-Com	8'	GEP-310	7453	\$64.74



“After a devastating injury or illness, many patients lose their sense of independence and control. Activities once performed effortlessly, may only be possible with the assistance of others. This device helps individuals start to see the things they can control — it gives them back a sense of independence.”

— Judith M. Burnfield, Madonna Rehabilitation Hospitals
Director, Institute for Rehabilitation Science and Engineering

Assistive Control Adaptor AC20

Many individuals with limited dexterity experience difficulty using traditional devices to call the nurse, control the television, or adjust lighting.

Working closely with a team at Madonna Rehabilitation Hospitals, and inspired by their First Hope technology, we designed the Assistive Control Adaptor. The Assistive Control Adaptor is a medical device per the FDA and meets all compliance requirements including UL 1069. It gives patients lacking hand control the ability to use sip-and-puff devices, button switches, or other types of sensors to call the nurse, control the TV, adjust lighting, and even open shades and drapes.*

Each device is configured individually for the patient and the type of switch that will be used, giving the patient the ability to navigate through menus and select options.

With the Assistive Control Adaptor, what previously required a visit from hospital staff can now be performed independently by the patient.

* The ability to control room features such as lights and shades is dependent on the existing capabilities of your nurse call system.



THE SYSTEM

The system has two main components — the Display Module and the Base Module.



DISPLAY MODULE

The Display Module mounts within view of the patient and provides access to nurse call, TV controls, and room controls*.

- ▶ The 4.3" LCD screen displays a menu that can be configured by your staff through which the patient selects various nurse call, entertainment, and room options
- ▶ Contains the speaker, headphone jack, and microphone used for communications with the nursing staff, as well as for entertainment audio
- ▶ Plugs into the Base Module, which supplies its power and connection to room devices and systems



BASE MODULE

The Base Module mounts on the head wall and provides control signals to the nurse call system and other hospital and entertainment systems.

- ▶ Powered by the included power supply
- ▶ Breath-actuated devices or other specialty call cords are connected to the two 1/4" jacks and two 1/8" jacks
- ▶ Buttons allow the caregiver to operate the system

INSTALLATION

Installation is simple. Just mount the two modules and plug them in and it's ready to use.

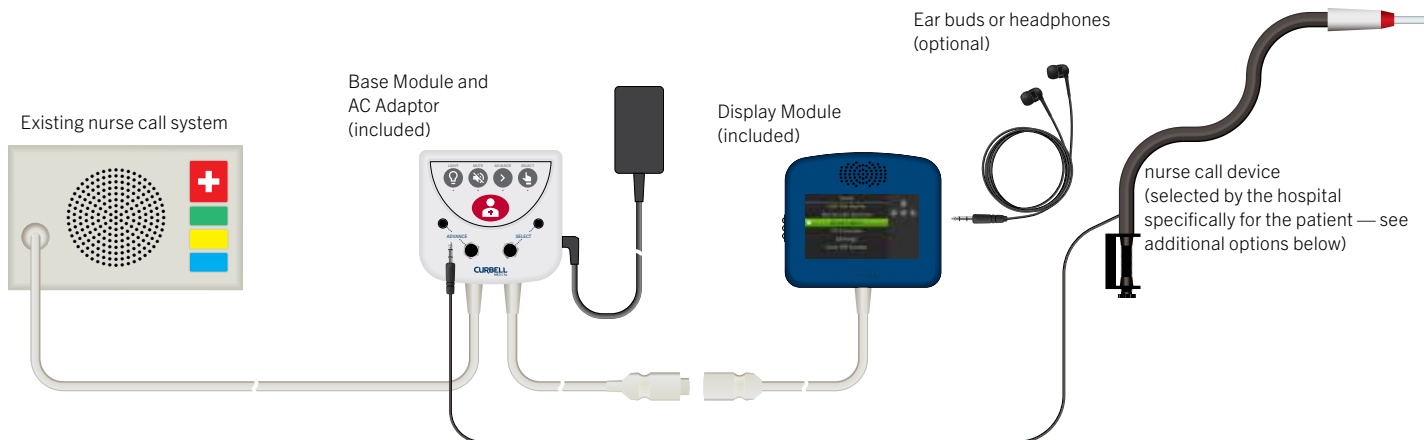

<p>A wide variety of input devices can be used, including these from Curbell.</p>	<p>BREATHCALL®</p>	<p>E-Z CALL™</p>	<p>PADCALL®</p>	<p>PRESSCALL®</p>	<p>MECHANICAL PAD</p>
---	---------------------------	-------------------------	------------------------	--------------------------	------------------------------

* The ability to control room features such as lights and shades is dependent on the existing capabilities of your nurse call system.

CONFIGURATION

The default settings will work with most patients, but there are numerous options that allow the device to be customized for each patient.

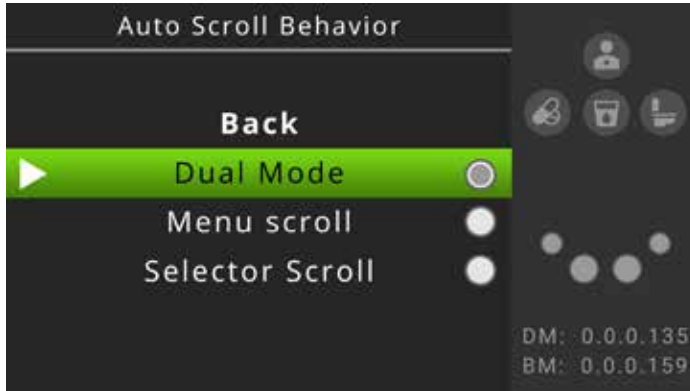

Settings like Auto Scroll Behavior set the device to operate in a way that's easiest for the patient, depending on the patient's abilities and what type of input device is being used.

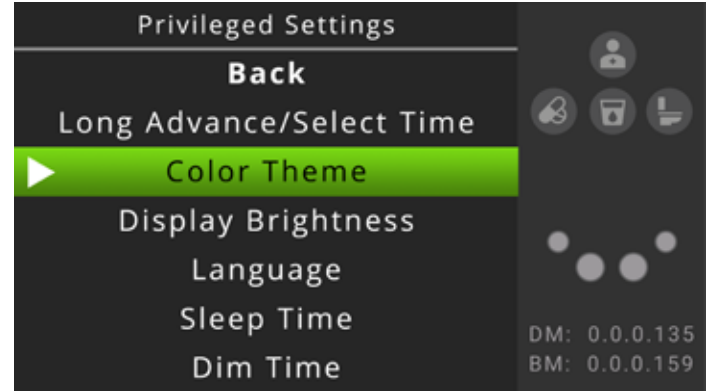

Settings like Color Theme, Display Brightness, and Language let you further customize the device for each patient.

USE

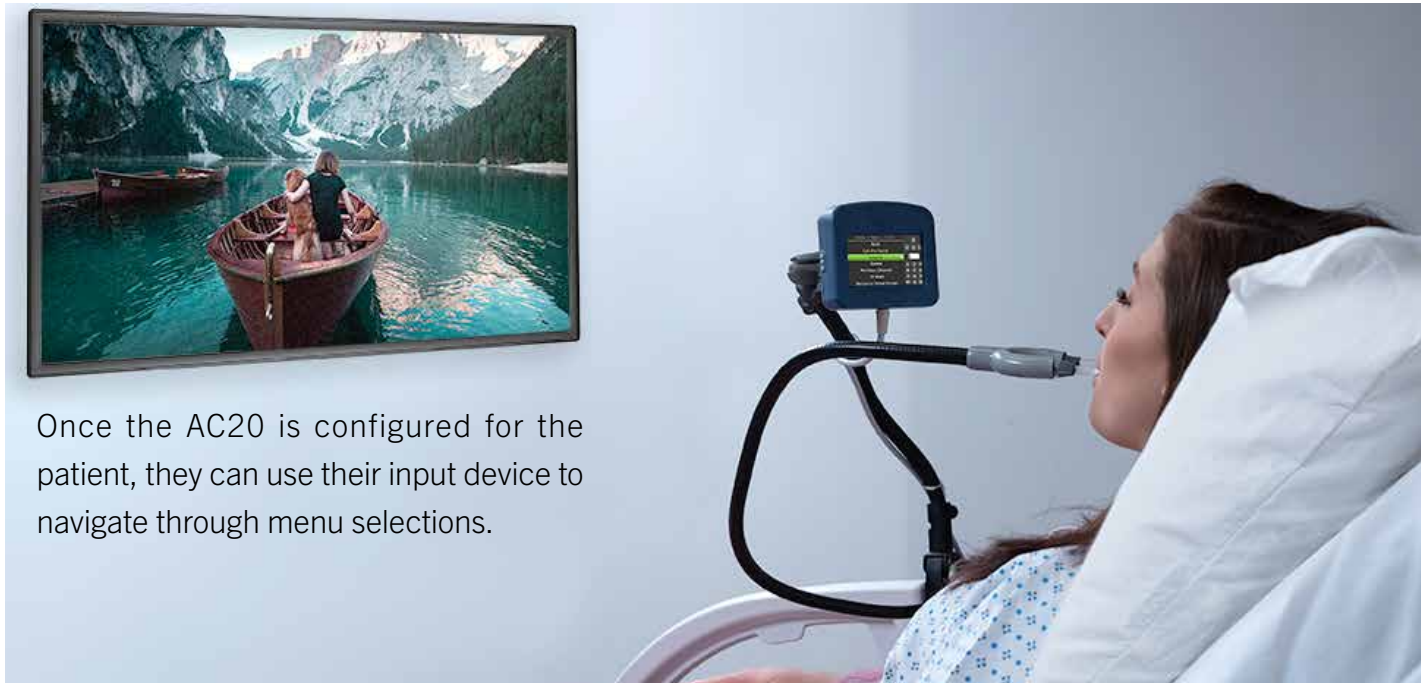

Once the AC20 is configured for the patient, they can use their input device to navigate through menu selections.

Shown here are screens that the patient will see when calling the nurse, and controlling lights and the television.

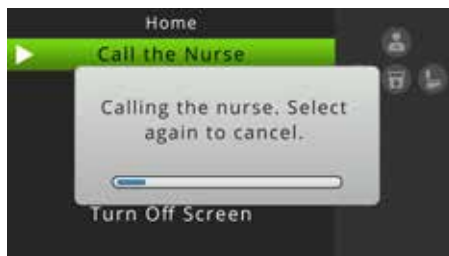

For safety and security, the "Call the Nurse" option is present on every screen. Once the call is initiated, the patient has the option to cancel the call.



If the lights are connected to the nurse call system, the patient can turn lights on and off.



The system can be configured to allow entry of a specific channel, saving the patient from having to cycle through all channels to get to the one they want.

AC20 MOUNTING



Both the Display and Base Modules can be mounted with various types of mounts. Both are equipped with AMPS mounting pattern holes.



DISPLAY MODULE MOUNTING

The Display Module can be mounted to the bed rail or pole using the display mount available from Curbell, or with a mount of the customer's choosing.

BASE MODULE MOUNTING

The Base Module can be mounted to the head wall using an adaptor from Curbell.

SPECIFICATIONS

Dimensions	Display Module: 5.25" x 4.5" x 1.25" (L x W x H) Base Module: 4.75" x 4.5" x 1.75" (L x W x H)
Mounting	Display Module: Bed rail or pole mount with AMPS mounting adaptor Base Module: Wall-mount or pole mount with AMPS mounting adaptor
Screen Dimensions	4.3" diagonal with Corning® Gorilla® Glass
Screen Resolution	1024 x 600
Backlight Type	LED
Speakers	1 Watt maximum (capped at 80dB @ 10cm +/- 5dB)
Headphone	1/8" stereo headphone socket on Display Module
Base Module Connectivity	Nurse Call System Interface cable (determined by nurse call system) Two 1/4" sockets for breath-activated or other call cord devices. Compatible to momentary, normally open, dry contact devices Two 1/8" sockets for breath-activated or other call cord devices. Compatible to momentary, normally open, dry contact devices
Base Module Power Supply	12V External (Included)

COMPONENTS

COMPONENT	DESCRIPTION	MODEL NUMBER	PART NUMBER	PRICE
Display Module	9' standard cable	ACD-1000-90101	26066	\$249.95
Base Module	36" nurse call cable, 8' power adaptor	ACB-0900-0001A08	25789	\$249.95
Display Mounts (both are required)	Gooseneck mount	MSC-1124-001	25855	\$89.95
	Gooseneck mounting plate	MSC-1125-001	25856	\$9.95
Base Mount	Headwall mount	BRK-1014-001	26001	\$17.95

NURSE CALL ADAPTORS



The needs of some patients may require that multiple nurse call devices are connected to your nurse call system. Our line of adaptors will give your nurse call system the flexibility to handle this increased demand. They're easy to install, feature strain relief on the cable, and are available with numerous receptacle options. Please call your Curbell representative to discuss the most effective solution for your specific needs.

BOX ADAPTORS

A mountable box style adaptor allows you to safely expand the interface capabilities of the in-room patient station. Curbell offers adaptors that have been tested directly with the nurse call systems to verify patient and system safety.



CONVERSION ADAPTORS

Specifically for instances when you have a single universal 1/4" nurse call device, but not a matching receptacle on the patient station, the conversion adaptor effectively changes the plug style.



JUMPER ADAPTORS

Help extend the life of your patient station and nurse call device cable with breakaway cables. Choose from 8-pin DIN, 9-pin DIN or 10-pin Modular styles.



! SEE PAGES 58-88 FOR ADAPTORS FOR EACH NURSE CALL SYSTEM

Curbell ensures that these products are validated to meet your intended needs for nurse call communication. Please contact Curbell with any questions regarding these adaptors.

WALL PLATES

- ▶ For standard or custom head- or foot-end installations
- ▶ Optional pigtails available for quicker installation
- ▶ Plastic plates available



WPA-0001



WPA-0005



WPA-0017

1/4" WALL PLATES

GANGS	SOCKET 1	SOCKET 2	PIGTAILS	DUPLEX	MODEL NUMBER	PART NUMBER	PRICE
1	1/4"	—	No	No	WPA-0002	13850	\$14.25
1	1/4"	Coax	No	No	WPA-0005	13852	\$15.25
1	1/4"	Coax	Yes	No	WPA-0152	13886	\$16.50
1	1/4"	1/4"	Yes	No	WPA-0182	13888	\$19.75
1	1/4"	—	Yes	No	WPA-0183	13889	\$16.50
2	1/4"	Coax	No	Yes	WPA-0036	13865	\$24.25
2	1/4"	Coax	Yes	Yes	WPA-0185	13890	\$32.95
3	1/4"	Coax	Yes	Yes	WPA-0419	13919	\$34.00

5-PIN RCA WALL PLATES

GANGS	SOCKET 1	SOCKET 2	PIGTAILS	DUPLEX	MODEL NUMBER	PART NUMBER	PRICE
1	5-pin RCA	Coax	No	No	WPA-0006	13853	\$15.25
1	5-pin RCA	—	No	No	WPA-0012	13856	\$13.25
1	5-pin RCA	Coax	Yes	No	WPA-0179	13887	\$18.95
1	5-pin RCA	—	Yes	No	WPA-0513	13931	\$16.50
2	5-pin RCA	Coax	No	Yes	WPA-0063	13870	\$24.25

6-PIN ZENITH WALL PLATES

GANGS	SOCKET 1	SOCKET 2	PIGTAILS	DUPLEX	MODEL NUMBER	PART NUMBER	PRICE
1	6-pin Zenith	Coax	No	No	WPA-0001	13849	\$21.95
1	6-pin Zenith	Coax	Yes	No	WPA-0004	13851	\$24.20
1	6-pin Zenith	6-pin Zenith	No	No	WPA-0008	13854	\$33.15
1	6-pin Zenith	—	No	No	WPA-0010	13855	\$19.95
1	6-pin Zenith	—	Yes	No	WPA-0088	13874	\$20.95
2	6-pin Zenith	Coax	No	Yes	WPA-0017	13859	\$30.90
2	6-pin Zenith	Coax	Yes	Yes	WPA-0466	13923	\$32.95
3	6-pin Zenith	Coax	Yes	Yes	WPA-0626	13947	\$41.95

COAX WALL PLATES

GANGS	SOCKET 1	SOCKET 2	PIGTAILS	DUPLEX	MODEL NUMBER	PART NUMBER	PRICE
1	Coax	—	No	No	WPA-0198	13895	\$12.00

RJ45 WALL PLATES

GANGS	SOCKET 1	SOCKET 2	SOCKET 3	PIGTAILS	DUPLEX	MODEL NUMBER	PART NUMBER	PRICE
1	RJ45	Coax	6-pin Zenith	Yes	No	WPA-0767	13991	\$52.65
1	RJ45	Coax	1/4"	Yes	No	WPA-0737	13977	\$45.95

TV JUMPER CABLES

Hospitals and installers have relied on Curbell for years to supply television jumper cables with a wide variety of plug styles, and our close relationships with healthcare television manufacturers ensures that the wiring is correct and up-to-date.

- ▣ Dozens of configurations
- ▣ Standard 36" length
- ▣ Custom lengths available



PLUG END 1	PLUG END 2	MODEL NUMBER	PART NUMBER	PRICE
1/4" Female	1/4" plug	JU06-550	8132	\$20.95
1/4" Female	1/8" 3-Conductor	JU36-781	8322	\$13.95
1/4" Female	1/8" 4-Conductor	JU36-513	8284	\$14.95
1/4" Female	6-pin Zenith	JU36-430	8270	\$19.95
1/4"	1/4" plug	JU36-030	8211	\$12.95
1/4"	1/8" 3-Conductor	JU36-780	8321	\$12.95
1/4"	1/8" 4-Conductor	JU36-503	8278	\$13.95
1/4"	5-pin Female RCA	JU36-005	8201	\$17.95
1/4"	5-pin RCA	JU36-040	8213	\$12.95
1/4"	5-pin DIN	JU36-TBD	TBD	Call
1/4"	RJ12	JU36-280	8259	\$12.95
1/4"	6-pin Zenith	JU36-050	8215	\$12.95
1/8" 3-Conductor	1/8" 3-conductor	JU36-777	8319	\$11.95
1/8" 3-Conductor	5-pin	JU36-770	8317	\$11.95
1/8" 3-Conductor	6-pin Zenith	JU36-720	8310	\$12.95
1/8" 4-Conductor	5-pin	JU36-505	8280	\$12.95
1/8" 4-Conductor	6-pin Zenith Female	JU36-516	8285	\$22.65
1/8" 4-Conductor	6-pin Zenith	JU36-506	8281	\$13.95
5-pin RCA	5-pin RCA	JU36-070	8219	\$12.95
5-pin RCA	RJ12	JU36-140	8237	\$12.95
6-pin Zenith	5-pin Female RCA	JU36-330	8265	\$20.95
6-pin Zenith	5-pin RCA	JU36-090	8224	\$12.95
6-pin Zenith	5-pin DIN	JU36-TBD	TBD	Call
6-pin Zenith (3 pins wired)	6-pin Zenith (3 pins wired)	JU36-110	8228	\$12.95
6-pin Zenith (all pins wired)	6-pin Zenith (all pins wired)	JU36-120	8233	\$13.95
6-pin Zenith	RJ12	JU36-150	8239	\$13.95
6-pin Zenith	bare wire	JU36-095	8225	\$8.95
Coax	Coax	JU36-010	8204	\$4.95
RJ45	6-pin Zenith	JU36-TBD	TBD	Call
RJ45	1/8" 3-conductor	JU36-TBD	TBD	Call

DUMMY PLUGS

Curbell's dummy plugs eliminate cord out alarms when the signaling device isn't plugged in. They are available for virtually any nurse call system or dedicated in-wall bed port.



















DP-100

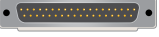

DP-010



DPG-0100-100

	PLUG END	CORD	NOTES	MODEL NUMBER	PART NUMBER	PRICE
	1/4" plug	—	Metal Plug	DP-010	6832	\$3.95
	1/4" plug	6" Poly Cord	Metal Plug	DP-020	6834	\$5.25
	1/4" plug	6" Poly Cord	Metal Plug, Normally Closed	DP-025	6835	\$5.25
	1/4" plug	6" Poly Cord	Plastic, White	DPG-0100-206	20173	\$2.75
	1/4" plug	—	Plastic, White	DPG-0100-100	20172	\$1.95
	10-pin Modular	6" Poly Cord		DP-255	6862	\$8.95
	12-pin Rauland	—	Jump 7 and 10	DP-200	6856	\$11.95
	36-pin centronics	7" Nylon-Coated Wire Rope	7 and 25, 10 and 11	DP-480	6869	\$12.95
	36-pin centronics	7" Nylon-Coated Wire Rope	7 and 25, 8 and 9, 10 and 11	DP-470	6868	\$12.95
	37-pin universal	6" Poly Cord	7 and 25, 8 and 9, 10 and 11	DP-110	6849	\$13.60
	37-pin universal	6" Poly Cord	7 and 25, 10 and 11	DP-100	6846	\$12.95
	RJ45	—	Jump 4 and 5	DP-082	6844	\$8.95
	8-pin DIN Jeron	—	—	DP-062	6840	\$8.95
	8-pin DIN Rauland	6" Poly Cord	—	DP-140	6852	\$9.95
	9-pin Zettler	6" Poly Cord	Sentinel 400, Jump 7 and 8	DP-160	6854	\$10.95
	9-pin Zettler	6" Poly Cord	Sentinel 500, Jump 4 and 9	DP-165	6855	\$10.95

! SEE PAGES 58-88 FOR SPECIFIC DUMMY PLUGS FOR YOUR NURSE CALL SYSTEM



BED COMMUNICATION CABLES AND ACCESSORIES

Bring your beds to life

With a custom communication cable from Curbell Medical, a bed comes to life. It becomes a communication center, linking the patient to nurse call systems, televisions, and other room technologies — even delivering potentially life-saving data. For more than 50 years, we have made sure that patients can expect the best possible experience; and our people make sure that our customers can expect the same. Let us help you find the right solution for you and your beds.

CHOOSING THE RIGHT SOLUTION

Healthcare beds represent a significant investment for hospitals, and many offer advanced features to ensure safety, enhance communication, and alert caregivers. In addition to powering the bed through the AC outlet connection, you will need to also ensure that the bed communication cable is plugged into the bed and wall receptacle to tie into the nurse call system to take advantage of these features. The most effective way to do that is with a cable from Curbell Medical.

This will ensure that patients can utilize the nurse call, TV, and room controls available on the bed side rails. In addition, this cable also ensures that a bed exit notification is sent to the care team through the nurse call system when enabled on the bed — ideal for patients identified at risk for falls.



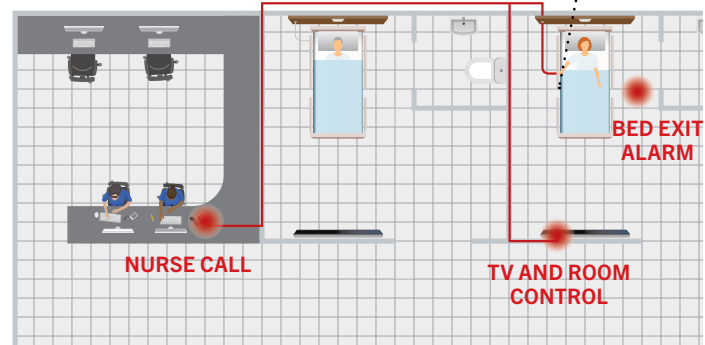
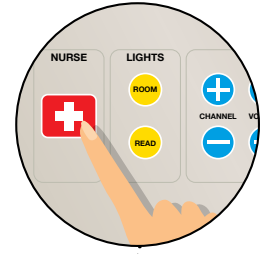

Our close relationships with bed and nurse call system manufacturers ensures that we can provide the right cable to properly communicate between your facility's various beds and nurse call systems.

Connecting your beds to the nurse call system gives access to numerous features



WHICH TYPE OF CABLE IS RIGHT FOR YOU?

Between the dozens of bed models, connector styles, and nurse call systems, there are hundreds of bed communication options to choose from. You can learn more about those options on the following pages. If you need more help determining what solution is right for you and your situation, call your Curbell sales representative at 1-800-235-7500.

	 BREAKAWAY CABLE (pages 39-45)	 STANDARD 37-PIN TO 37-PIN INLINE CABLE (page 46)	 STANDARD 37-PIN TO 37-PIN 90° CABLE (page 46)	 37-PIN BED-TO-NURSE CALL CABLE (page 47)
You're plugging into a standard 37-pin receptacle or Hillrom® Bed Interface Unit	●	●	●	
Space is too tight for an inline cable	●		●	
You're plugging directly into a patient station	●	●	●	●
You want to control lights or TV from the bed	●	●	●	●
You're having issues with plug and receptacle damage	●		●	●
Allows standardized bed connection in rooms with different bed or nurse call systems	●			

BREAKAWAY CABLES SOLVE THREE MAIN ISSUES

1 ONE STANDARDIZED BED AND NURSE CALL CONNECTION

If your facility has multiple types of nurse call systems or beds, moving beds from room to room can be a challenge. Curbell's breakaway cables give you a common connection in every room regardless of bed type or nurse call system. One section is permanently attached at the wall, and the other section is permanently attached to the bed. Use them throughout your facility, and you can freely move beds from room to room.

Watch a video at www.curbellmedical.com/breakaway-bed-cables/

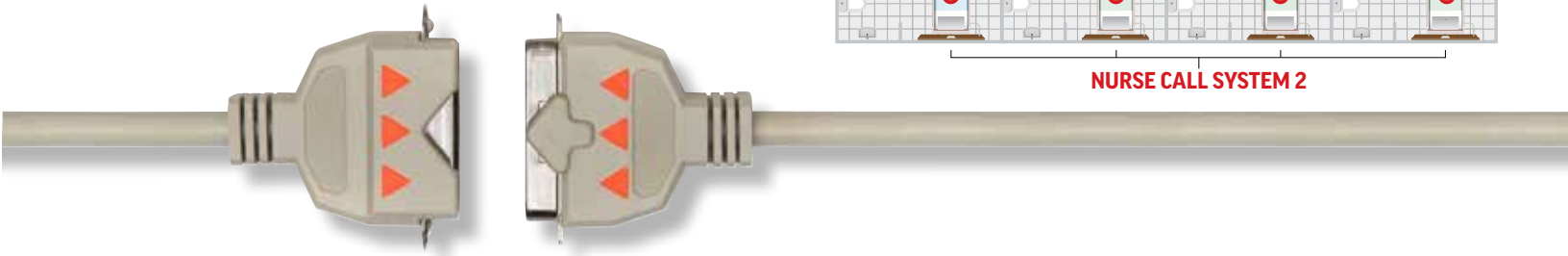
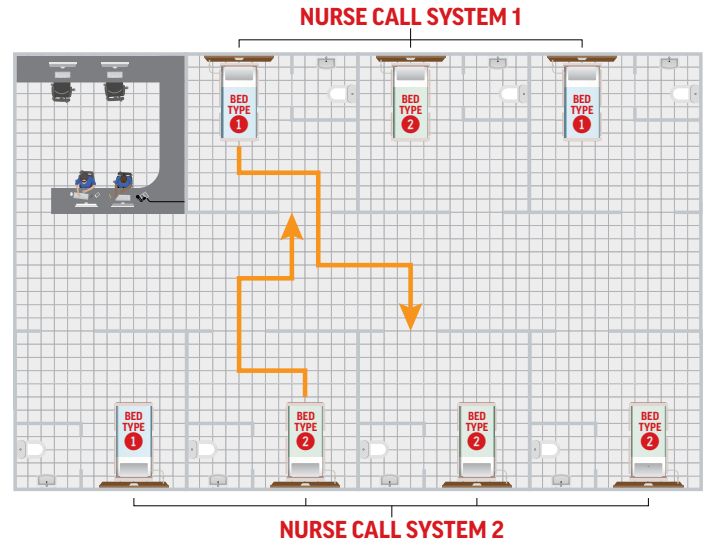

2 MINIMIZE RECEPTACLE AND CABLE DAMAGE



Aside from being a costly repair, a damaged wall receptacle or patient station can put a room out of service for days. By using a breakaway cable from Curbell, you minimize the chance of this type of damage happening. If the bed is moved without disconnecting the cable, the unique two-piece design safely breaks apart at a point away from the wall, reducing cable replacement and receptacle repair costs, and most importantly, minimizing patient risk.



Cables and wall receptacles incur damage when the bed cable isn't unplugged before moving the bed.



The pinless connectors on our breakaway cables have no pins to break.

3 FULLY UTILIZE ALL YOUR BED'S FEATURES



Are the advanced features of your beds going unused because it's too much trouble to plug them in? With a bed communication cable from Curbell Medical, a bed comes to life. It becomes a communication center, linking the patient to nurse call systems, televisions, and other room technologies — even delivering potentially life-saving data. Using a breakaway cable lets you use all the features of the bed while having a simple and quick way to disconnect the bed when it needs to be moved.

BREAKAWAY CABLES

CUSTOMER THOUGHTS ON COST:

“A replacement wall station is \$450, and cables vary from \$40 to \$200, not counting labor. We needed a solution to avoid replacing them time after time. Installing the Breakaway Bed Cables was easy: just plug in and attach to the wall and bed. It was simple and reduced costs.”

Mark Dandurand,
Maintenance Mechanic
MetroSouth Medical Center, Blue Island, IL

CUSTOMER THOUGHTS ON EFFICIENCY:

“Breakaway Bed Cables are faster to hook up by far. Conventional cords take twice as long. In an emergency situation, the bed can just break away without causing lasting damage. Plus, it works universally with any brand of hospital bed. You can even use it as an adaptor. Everyone benefits from the breakaway cables.”

Chris Bowers
Biomedical Engineering
Artesia General Hospital, Artesia, NM

CUSTOMER THOUGHTS ON SAFETY:

“[Cables] were always missing or broken, and if a bed wasn't connected as a result, the patient could be at risk. With breakaway cables, there is less risk of patient falls. We're always alerted when a patient gets up, so we can stop falls before they happen”

Leslie Szalkowski
Registered Nurse
St. Luke's Hospital, Maumee, OH

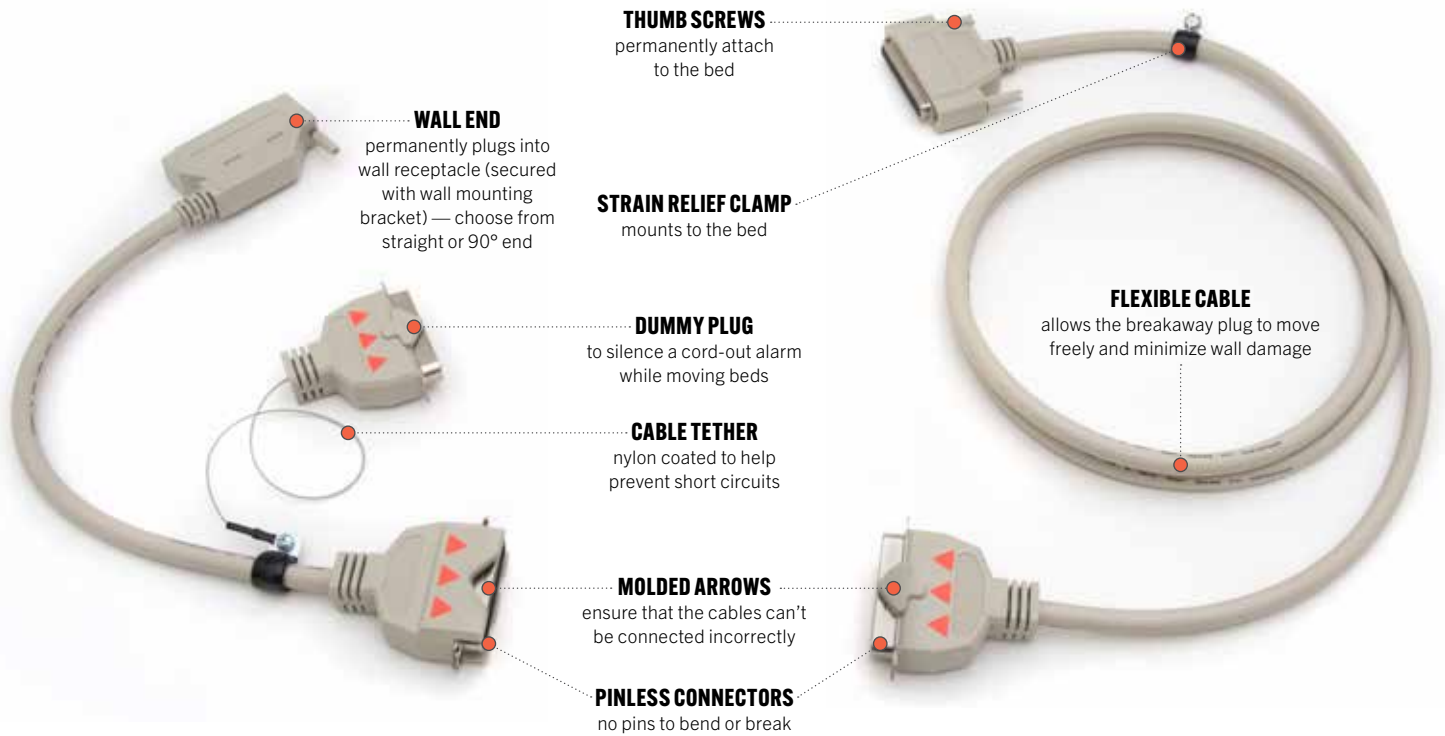

USING THE BREAKAWAY CABLE IS SIMPLE



1 Plug the wall end of the cable into the wall plate and tighten the thumbscrews.



2 Install the bracket to permanently mount the cable (see pages 44-45 for information on brackets).



3 Plug the cable into the bed, tighten the thumbscrews, and screw the strain relief clamp into the bed to permanently mount the cable.

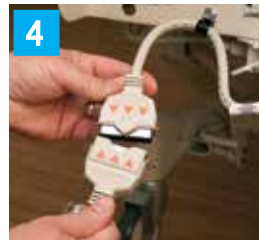

4 Connect the breakaway cable's pinless connectors.













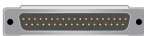











5 When moving the bed, disconnect the cables and place the dummy plug into the wall end of the cable.

BREAKAWAY CABLES

STANDARD 37-PIN FULL BREAKAWAY CABLES

Part numbers for most common standard 37-pin connections are listed below. Other sizes are available.









WALL END			BED END			FULL CABLE		
WALL END	ANGLE	LENGTH	BED END	LENGTH	MODEL#	PART #	PRICE	
 37-Pin male	 straight	1 ft.	 37-Pin female, Hillrom*	6 ft.	BCC-3002-A01-A06-001	22360	\$66.78	
 37-Pin male	 90°	1 ft.	 37-Pin female, Hillrom*	6 ft.	BCC-3003-A01-A06-001	22363	\$66.78	
 37-Pin male	 straight	6 ft.	 37-Pin female, Hillrom*	1 ft.	BCC-3002-A06-A01-001	22362	\$66.78	
 37-Pin male	 90°	6 ft.	 37-Pin female, Hillrom*	1 ft.	BCC-3003-A06-A01-001	22365	\$66.78	
 37-Pin male	 straight	1 ft.	 37-Pin male, Stryker**	6 ft.	BCC-3002-A01-E06-001	22361	\$66.78	
 37-Pin male	 90°	1 ft.	 37-Pin male, Stryker**	6 ft.	BCC-3003-A01-E06-001	22364	\$66.78	
 37-Pin male	 straight	6 ft.	 37-Pin male, Stryker**	1 ft.	BCC-3002-A06-E01-001	3527	\$66.78	
 37-Pin male	 90°	6 ft.	 37-Pin male, Stryker**	1 ft.	BCC-3003-A06-E01-001	3557	\$66.78	

STANDARD 37-PIN HALF BREAKAWAY CABLES





Each half of the breakaway cable is available separately.

One and six foot lengths are shown below, but they're also available in 2, 4, 8, 10, 12, and 15 foot lengths.

WALL END HALF CABLE

WALL END	ANGLE	LENGTH	MODEL #	PART #	PRICE
 37-Pin male	 straight	1 ft.	BCC-5002-A01-001	22366	\$44.50
 37-Pin male	 90°	1 ft.	BCC-5003-A01-001	22367	\$44.50
 37-Pin male	 straight	6 ft.	BCC-5002-A06-001	3636	44.50
 37-Pin male	 90°	6 ft.	BCC-5003-A06-001	3642	\$44.50

BED END HALF CABLE

BED END	LENGTH	MODEL #	PART #	PRICE
 37-Pin female, Hillrom*	6 ft.	BCC-5001-A06	3623	\$44.50
 37-Pin female, Hillrom*	1 ft.	BCC-5001-A01	3621	\$44.50
 37-Pin male, Stryker**	6 ft.	BCC-5001-E06	3630	\$44.50
 37-Pin male, Stryker**	1 ft.	BCC-5001-E01	3627	\$44.50

! SEE PAGES 42-43 FOR OTHER CONNECTIONS

* Also for Linet®, Joerns®, and Novum® beds

** Also for Amico®, Arjo®, Carroll® (CHG®), Kreg Medical, Next Health®, OnCare®, Rotec, Sizewise®, Stryker® London, Umamo Medical, and VitalGo beds

BED-TO-NURSE CALL BREAKAWAY CABLES

Curbell offers Breakaway Cables that connect directly to most nurse call systems. With one of these cables, you can be assured that you're getting the maximum functionality out of your beds and nurse call system.

- ▶ Available for 37-pin male plug beds
 - ▣ Hillrom®
 - ▣ Joerns, Linet®, and Novum
- ▶ Available for 37-pin female plug beds
 - ▣ Stryker®
 - ▣ Amico, Arjo®, Carroll® (CHG®), Kreg Medical, Next Health, Oncare®, Rotec, Sizewise, VitalGo, Umano Medical
- ▶ 8' standard length, other lengths available
- ▶ One year warranty



FOR RAULAND RESPONDER IV®





The 800/102 Breakaway Cable allows the wall half of the breakaway cable to be plugged directly into Rauland patient stations with an 8-pin DIN (for regular nurse call), and a 1/4" auxiliary port (for the bed exit alarm).





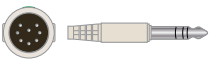

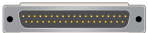
FOR RAULAND RESPONDER 4000, 5, 5000, ENTERPRISE

The 1/4" Breakaway Cable allows for Bed Exit and/or Nurse Call-only applications. It's a simple and reliable solution when you don't have the need or ability to use a 37 pin breakaway cable. Call for additional plug styles.





		3605	\$83.50
8-pin DIN and 1/4" plug, 1 foot length with dummy plug	Hillrom, 6 ft. length		
		3606	\$83.50
	Stryker, 6 ft. length		
		16894	\$83.50
8-pin DIN and 1/4" plug, 6 foot length with dummy plug	Hillrom, 1 ft. length		
		17191	\$83.50
	Stryker, 1 ft. length		

		3426	\$48.62
1/4" plug Nurse Call Only 6 foot length	Hillrom, 8 ft. length		
		15791	\$48.62
	Stryker, 8 ft. length		
		17077	\$48.62
1/4" plug Nurse Call and bed exit 6 foot length	Hillrom, 8 ft. length		
		17772	\$48.62
	Stryker, 8 ft. length		



FOR ASCOM/GE TELLIGENCE®

Our breakaway cable for Telligence systems use extra long screws provide a secure fit at the patient station. Dummy plug included.

WALL END	DESCRIPTION	PART #	PRICE
	Hillrom* 1 ft. bed end, 6 ft. wall end 6 ft. bed end, 1 ft. wall end	18625 18623	\$66.78 \$66.78
	Stryker** 1 ft. bed end, 6 ft. wall end 6 ft. bed end, 1 ft. wall end	18626 18624	\$66.78 \$66.78

ASCOM/GE TELLIGENCE SCREW

Longer screws for securing cables to Telligence patient stations (two are required per station)



MODEL #	PART #	PRICE
HW-814	7645	\$.79 each

FOR PATIENT STATIONS WITH 1/4" JACKS

The 1/4" Breakaway Cable allows for bed exit and/or nurse call-only applications. It's a simple and reliable solution when you don't have the need or ability to use a 37-pin breakaway cable. Call us for additional plug styles.

WALL END	DESCRIPTION	PART #	PRICE
	Hillrom* 8 ft. bed end, 6" wall end with dummy plug	3426	\$48.62

CURBELL OFFERS BREAKAWAY CABLES TO CONNECT YOUR BEDS TO THESE NURSE CALL SYSTEMS:



ASCOM®/GE

18 pin connector
Telligence™



AUSTCO®

8 pin DIN connector
MediCom
Tacera



CRITICAL ALERT®*
8 pin modular connector
SPS101
System 200, 1000/3000

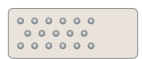

DUKANE

17 pin connector
ProCare 2000®
System 2070

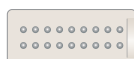

DUKANE

18 pin connector
ProCare 4000
ProCare 6000
System 2070



FISHER BERKELEY

15 pin connector
HP Series
MMC Series

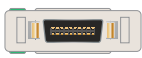

HILLROM®

20 pin connector
COMposer®
NaviCare®

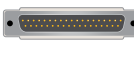

HILLROM®

37 pin connector
DB37
Headwall



INTERCALL

8 pin DIN connector
Legend II, Equinox II,
Spectrum II,
Ultra 6000, 6900, 9000



JERON®

8 pin DIN connector
Pro-Alert™ 640
Provider® 680 and 790
Spectrum® Pro IR



RAULAND

8 pin DIN connector
Responder III+, IV
Responder 4000, 5, 5000
Responder Enterprise



SIMPLEXGRINNELL®

15 pin connector
EZCare™



TEKTONE®

8 pin DIN connector
Tek-CARE® NC300 II
Tek-CARE 400



TEKTONE

8 pin modular connector
Tek-CARE NC300 II



WEST-COM

8 pin modular connector
1000, 8000
Endeavor
Marc II



WEST-COM

10 pin Modular connector
Odyssey,
Odyssey Plus, Novus



ZETTLER

9 pin connector
Sentinel 400™,
Sentinel 500™

* formerly Intego and Wescom

BREAKAWAY CABLE LOCKING SOLUTIONS

For a cable to separate at the breakaway point, it needs to be secured at both the bed end and the wall end. Curbell offers several options to secure the cable to different nurse call receptacles or Bed Interface Units.

WALL PLATE MOUNTING

Our breakaway cable wall plates can be connected without rewiring. Just remove the existing wall plate, then connect your existing female 37-pin receptacle to the male 37-pin connector on the back of the breakaway cable wall plate.



INLINE CABLE WALL PLATE/BRACKET

Allows you to secure inline breakaway cables



DESCRIPTION	MODEL #	PART #	PRICE
Bracket and wall plate	WPA-0719	13971	\$31.15
Bracket only	BRK-1004-001	4077	\$10.76

90° CABLE WALL PLATE/BRACKET

Allows you to secure 90° breakaway cables



DESCRIPTION	MODEL #	PART #	PRICE
Bracket and wall plate	WPA-0713	13968	\$31.15
Bracket only	BRK-1003-001	4076	\$10.76

BRACKETLESS WALL PLATE

Secures the breakaway cable using the bed cable mounting screws



MODEL #	PART #	PRICE
WPA-0608	13944	\$11.44

DUAL 90° LOCKING BRACKET (wall plate 13944 sold separately)

Secures two 90° breakaway cables to a dual 37-pin wall plate



MODEL #	PART #	PRICE
BRK-1007-001	17036	\$6.75

37 PIN RECEPTACLE KITS FOR RAULAND RESPONDER 5/ENTERPRISE

Receptacle kits include the wiring harnesses for Responder 5/Enterprise systems (NCBED5 receptacle) to make installation quick and easy. The bracket allows you to secure breakaway cables. Models with a 1/4" jack allow connection of a call cord.

1/4" JACK	CABLE ANGLE	MODEL #	PART #	PRICE
No	Straight	RCK-1059-001	22560	\$74.70
	90°	RCK-1057-001	22558	\$74.70
Yes	Straight	RCK-1058-001	22559	\$98.66
	90°	RCK-1055-001	20532	\$94.57



22560



22558



22559



20532

HILLROM COMPOSER BIU 90° BRACKET
Secures 90° cables to Hillrom BIUs



MODEL #	PART #	PRICE
HDW-3005-001	7512	\$7.30

HILLROM COMPOSER BIU BRACKET
Secures cables to Hillrom BIUs



MODEL #	PART #	PRICE
HDW-3000-001	7511	\$4.15

HILLROM INLINE NAVICARE ASBC CABLE BRACKET
Secures inline cables to Hillrom Bed ASBC Units



MODEL #	PART #	PRICE
HDW-3007-001	19405	\$8.35

HILLROM 90° NAVICARE ASBC CABLE BRACKET
Secures 90° cables to Hillrom Bed ASBC Units



MODEL #	PART #	PRICE
HDW-3006-001	19253	\$8.35

WEST-COM BIU 90° CABLE BRACKET
Secures 90° cables to WestCall BIUs



MODEL #	PART #	PRICE
HDW-3008-001	25913	\$7.30

WALL OR BED CABLE BRACKET

Secures cables to beds or non-37-pin wall plates



MODEL #	PART #	PRICE
HW-130 (.25" diameter)	7594	\$1.58
HW-150 (.375" diameter)	7596	\$1.58

GENDER CHANGERS/PIN SAVERS

GENDER CHANGER: Change the gender of the connector on the wall or bed to give you a universal connector throughout your facility.

- Use a male/male gender changer to convert a female connection to a male connection
- Use a female/female gender changer to convert a male connection to a female connection

PIN SAVER: Pins on wall plates and beds can be easily damaged, and repairing them can be expensive. Pin savers have a female connection on one side and a male connector on the other, so they can be used on any 37-pin connector. Once connected, any pin damage will be inflicted on the pin saver, rather than the cable or bed.



TYPE		SIDE 1	SIDE 2	PINS	MODEL #	PART #	PRICE
Gender Changer		male	male	hollow crimped	MS-825	9506	\$12.55
		female	female	NA	MS-826	9507	\$12.55
Pin Saver		male	female	solid	MS-823	9505	\$12.55
		female	male	hollow crimped	MS-820	9502	\$8.35

STANDARD 37-PIN TO 37-PIN BED CABLES

A full variety of connector types are available, enabling you to connect from the bed to your 37-pin wall receptacle, or Hillrom® Bed Interface Unit.

- ▶ Available for most beds (see chart below)
- ▶ Solid metal pins provide the most strength and reliability
- ▶ Inline or 90° plugs
- ▶ 8' standard length, other lengths available
- ▶ One year warranty

SOLID PINS VS. ROLLED PINS



Solid Pins (Cross Section)

Curbell's bed cables use solid gold-plated pins to provide greater strength and stability.



Rolled Pins (Cross Section)

Many inexpensive bed cables use rolled pins, which are hollow and can deform easily.



8448 (90° cable)

For when the wall receptacle is above the bed, or for use in tight spaces

8447 (inline cable)

For when the wall receptacle is approximately at the same height as the bed

The most common 37-pin bed communication cables are shown below.

Contact your Curbell sales representative for information on other styles and cable lengths

WALL END		BED END		LENGTH	MODEL #	PART #
	37-Pin male, straight inline		37-Pin female, Hillrom*	8 feet	BIC-3600-A00-8	8447
	37-Pin male, 90° angle		37-Pin female, Hillrom*	8 feet	BIC-3690-A00-8	8448
	37-Pin male, straight inline		37-Pin male, Stryker**	8 feet	BIC-3600-E00-8	8450
	37-Pin male, 90° angle		37-Pin male, Stryker**	8 feet	BIC-3600-F00-8	8449

* Also for Linet®, Joerns®, and Novum® beds

** Also for Amico®, Arjo®, Carroll® (CHG®), Kreg Medical, Next Health®, OnCare®, Rotec, Sizewise®, Stryker® London, Umano Medical, and VitalGo beds















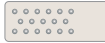
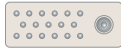











STANDARD BED-TO-NURSE CALL CABLES

If you need to interface your beds with your Nurse Call system, Curbell can meet your specific wiring needs for the hundreds of possible configurations.

- ▣ Available for 37-pin male plug beds
 - ▣ Hillrom®
 - ▣ Joerns, Linet®, and Novum
- ▣ Available for 37-pin female plug beds
 - ▣ Stryker®
 - ▣ Amico, Arjo®, Carroll® (CHG®), Kreg Medical, Next Health, Oncare®, Rotec, Sizewise, VitalGo, Umamo Medical
- ▣ For all common Nurse Call systems (see chart below)
- ▣ 8' standard length, other lengths available
- ▣ One year warranty



CURBELL OFFERS CABLES TO CONNECT YOUR BEDS TO THESE NURSE CALL SYSTEMS:

 ASCOM®/GE® 18 pin connector Telligence™	 AUSTCO® 8 pin DIN connector MediCom Tacera	 CRITICAL ALERT®* 8 pin modular connector SPS101 System 200 System 1000/3000	 DUKANE** 13 pin connector System 2000, 2010, 2020, 2030	 DUKANE 14 pin connector ProCare 2000® System 2070	 DUKANE 18 pin connector ProCare 2000® System 2070
 DUKANE 18 pin connector ProCare 4000 ProCare 6000 System 2070	 EKTACOM** 8 pin connector HB, HV-03 Series	 EXECUTONE** 8 pin connector Care/Com, Futura	 EXECUTONE 16 pin connector Lifesaver	 FISHER BERKELEY 15 pin connector HP Series MMC Series	 HCE/SYLVANIA® 20 pin connector
 HILLROM® 20 pin modular connector COMposer® NaviCare®	 HILLROM® 37 pin connector DB37 Headwall	 INTERCALL** 8 pin connector Legend II Equinox II	 INTERCALL 8 pin DIN connector Legend II, Equinox II, Spectrum II, Ultra 6000, 6900, 9000	 JERON® 8 pin DIN connector Pro-Alert™ 640 Provider® 680 and 790 Spectrum® Pro IR	 RAULAND** 12 pin connector Responder III Responder 3000
 RAULAND 8 pin DIN connector Responder III+ IV Responder 4000, 5000 Responder Enterprise	 SIMPLEXGRINNELL® 15 pin connector EZCare™	 TEKTONE® 8 pin DIN connector Tek-CARE® NC300 II Tek-CARE 400	 TEKTONE 8 pin modular connector Tek-CARE NC300 II	 WEST-COM 8 pin modular connector 1000, 8000 Endeavor Marc II	 WEST-COM 8 pin modular connector Odyssey Odyssey Plus Novus
 WEST-COM 12 pin connector Odyssey Odyssey Plus Novus	 ZETTLER®** 6 pin connector Zetcom	 ZETTLER® 9 pin connector Sentinel 400™ Sentinel 500™	 UNIVERSAL 1/4"*** Three conductor (shown) Two conductor	<div style="background-color: #0070C0; color: white; padding: 10px; text-align: center;"> SEE PAGES 42-43 FOR BREAKAWAY VERSIONS OF MANY OF THESE CABLES </div>	





* formerly Intego and Wescom ** these systems are not compatible with breakaway bed cables

RECEPTACLE KITS

Receptacle kits provide a dedicated bed port for professional connection to communication side rail beds

- ▶ Stainless steel wall plate
- ▶ Three dedicated pigtail sets (nurse call, entertainment, lighting) for easy routing of wire sets
- ▶ Individual conductors are stripped 1"
- ▶ One year warranty

Common styles are shown below. Contact your Curbell Sales Representative for additional styles.

PINS	LENGTH	DUMMY PLUG	MOUNTING BRACKET	MODEL #	PART #	PRICE
 37	8'	yes	no	RK-060	13102	\$64.38
 37	12'	yes	no	RK-070	13104	\$73.11
 37	20'	yes	no	RK-100	13108	\$90.58
 37	8'	no	for inline cables	RCK-1030-096	13040	\$79.36
 37	8'	no	for 90° cables	RCK-1021-096	13038	\$77.53



RK-060: 8' pigtails
RK-070: 12' pigtails (pictured)
RK-100: 20' pigtails



RCK-1030-096
with a mounting bracket for inline cables







RCK-1021-096
with a mounting bracket for 90° cables

37-PIN DUMMY PLUGS

Curbell's dummy plugs eliminate cord-out alarms when the signaling device isn't plugged in. They are available for virtually any nurse call system or dedicated in-wall bed port. Common styles are shown below. See page 36 for nurse call dummy plugs.



DP-100

PLUG END	CORD	JUMPED PINS	MODEL #	PART #	PRICE
 36-pin centronics (for breakaway cables)	10" 3/64" OD nylon-coated stainless steel	7 and 25, 10 and 11	DP-480	6869	\$12.55
 36-pin centronics (for breakaway cables)	10" heavy duty 1/8" OD nylon-coated stainless steel	7 and 25, 10 and 11	DP-481	6870	\$13.80
 36-pin centronics (for breakaway cables)	10" 3/64" OD nylon-coated stainless steel	7 and 25, 8 and 9, 10 and 11	DP-470	6868	\$12.55
 37-pin universal	6" poly cord	7 and 25, 8 and 9, 10 and 11	DP-110	6849	\$13.60
 37-pin universal	6" poly cord	7 and 25, 10 and 11	DP-100	6846	\$12.55



LOW VOLTAGE CONTROLLERS

Give your patients control of their environment

Curbell's low voltage controllers allow patients to safely operate high-voltage circuits such as lights, electric doors, and drapes with their pillow speaker or bed communication side rail. We offer models to mount either in the wall/headwall or in the lighting fixture itself. Our latest model, the LVC-2000 (page 52), is our most advanced low voltage controller yet, with the ability to control up to three loads with dimming.

GETTING THE MOST FROM YOUR NURSE CALL SYSTEM



😊 INCREASE PATIENT SATISFACTION

Studies have shown that a patient's ability to control their room lighting enhances the healing process¹. Now, hospitals can give their patients increased lighting and environmental control through the use of Curbell's advanced low voltage controller.

The LVC-2000 series of low voltage controllers from Curbell can give your patients control of up to three room features, including dimmable lights, heating/cooling, and even motorized shades, drapes, or doors.

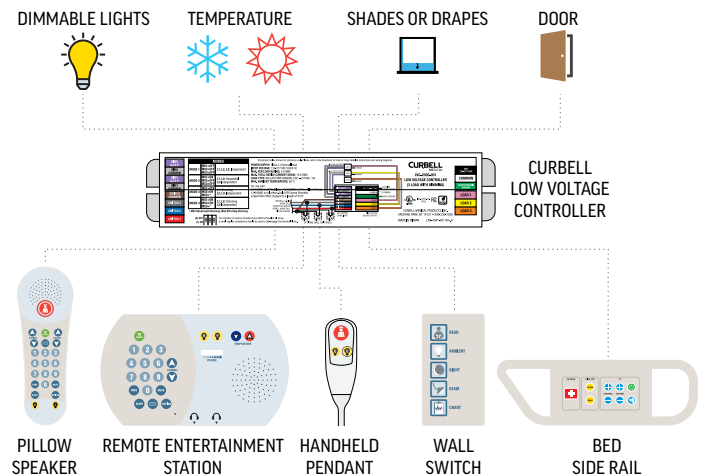

⌚ MAXIMIZE EFFICIENCY



Curbell offers low voltage controllers that are compatible with incandescent, fluorescent, and LED lighting.



Curbell's low voltage controllers cover all your needs throughout your hospital, with models available to mount in the wall or light fixture.



Color-coded push pin connectors reduce installation time.

1. <http://www.hermanmiller.com/research/research-summaries/patient-rooms-a-changing-scene-of-healing.html>

CHOOSING THE RIGHT LOW VOLTAGE CONTROLLER

The chart below gives a quick overview of the main differences between our various low voltage controllers. Our most popular configurations are listed, but if you have specific requirements, we can create a custom configuration to meet them. Contact your contact representative for more information.

	LVC-2000 Series (page 52)	LC-060 (page 54)	LVC-3000-001 (page 55)
Dimming	Yes	—	—
Mounting	Five gang box (ceiling or wall)	Five gang box (ceiling or wall)	Two gang box (ceiling or wall)
	Lighting fixture	Lighting Fixture	
Compatible Lamps	LED (all LVC-2000 series)	LED	LED
	Fluorescent (LVC-2000-001)	Fluorescent	Fluorescent
Number of Loads	Three	Two	Two
Voltage Range	120-277	120-277	120-277

Give your staff easy access to patient room lighting with the Low Voltage Controller Wall Switch. It can be placed at the entrance of the room, next to the patient's bed, or anywhere in the patient room that is convenient for the staff. See page 56.



INSTALLATION AND WIRING

A qualified electrical contractor or a hospital staff electrician should do the installation to make sure that all national and local electrical codes are followed. There are many different room layouts, but what's pictured here is a fairly common setup.

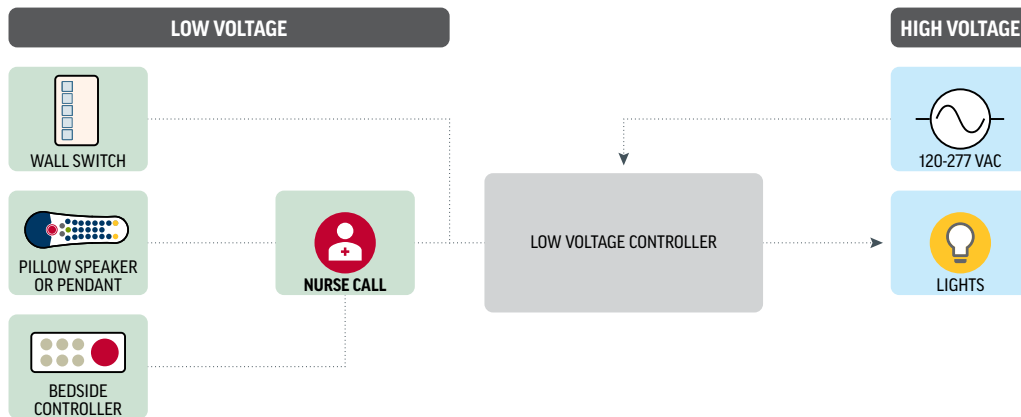

WIRING DIAGRAMS

Wiring diagrams and mode settings for our low voltage controllers are included in the directions for use, as well as on our website: www.curbellmedical.com/lvc-wiring



DIMMING LOW VOLTAGE CONTROLLER

FOR LIGHTING FIXTURE, HEADWALL, AND CEILING APPLICATIONS

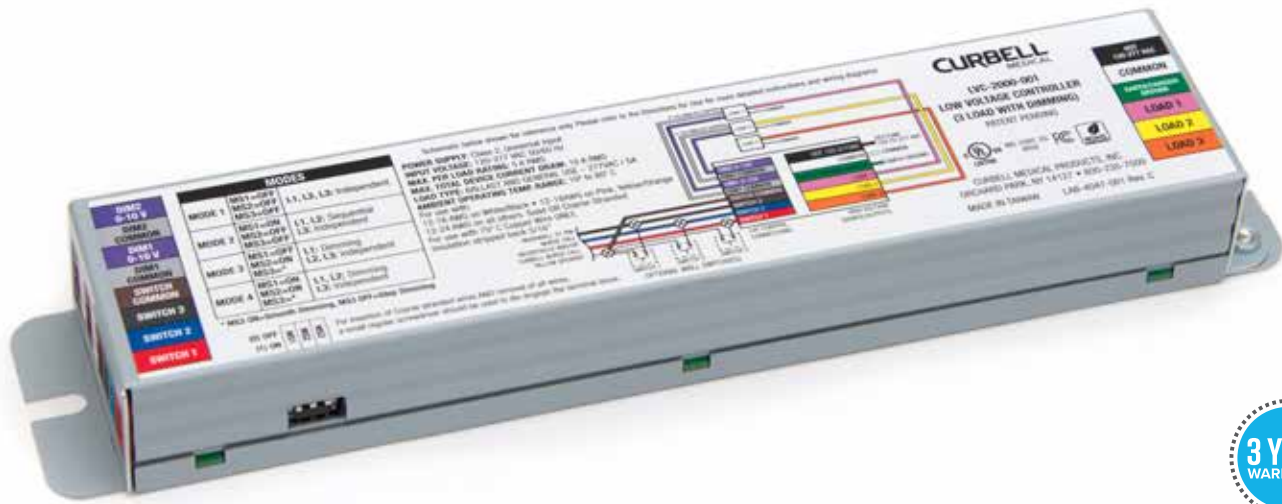

The LVC-2000 is our most capable and flexible low voltage controller. Its small size allows mounting into lighting fixtures and masonry boxes, and its ability to control three loads gives you lots of options for various lighting configurations. Most importantly, it allows dimming, giving your patients the ability to set the lighting to the level that makes them the most comfortable.

- ▶ True universal voltage (120-277 VAC)
- ▶ Can be used to operate high-voltage circuits such as lights, electric doors, blinds, and drapes
- ▶ For use with fluorescent, LED, and other lamp types
- ▶ Can be controlled from a pillow speaker, bed side rail, or wall switch with normally-open momentary dry contacts
- ▶ Can be set up for multiple modes of operation:
 - ▶ Three loads independently (on/off)
 - ▶ Two loads sequentially (on/off) and a third load independently (on/off)
 - ▶ One load independently (on/off) with 0-10V dimming control and second and third load independently (on/off)
 - ▶ Two loads independently (on/off) with 0-10V dimming control and a third load independently (on/off)
- ▶ Safe for use near medical equipment that is sensitive to electromagnetic noise

CONFIGURATIONS

Our most popular configurations are shown below. Other low voltage controllers with different configurations are available, and we can also create a custom configuration to meet your requirements.

LVC-2000-001

- ▶ 0-10V dimming with LED lights (with dimming driver) or fluorescent lights (with ballast)
 - ▶ Supports one direction smooth or step dimming from 100% to off
-

LVC-2000-004

- ▶ 0-10V dimming with LED lights (with dimming driver)
 - ▶ Supports bi-directional smooth dimming from 25% to 100% with quick on/off
 - ▶ Supports one direction step dimming from 100% to off
-

LVC-2000-006

- ▶ 0-10V dimming with LED lights (with dimming driver)
 - ▶ Supports bi-directional smooth dimming from 100% to off
 - ▶ Supports one direction step dimming from 100% to off
 - ▶ Exam light override (turns two loads to maximum brightness)
-

MODES		POWER SUPPLY INPUT VOLTAGE MAX. PER LOAD MAX. TOTAL ON LOAD TYPE: BA AMBIENT OPER. For use with: 12-16 AWG on 1 12-24 AWG on 2 For use with 75° insulation strips	
MODE 1	MS1=OFF MS2=OFF MS3=OFF		L1, L2, L3: Independent
MODE 2	MS1=ON MS2=OFF MS3=OFF		L1, L2: Sequential L3: Independent
MODE 3	MS1=OFF MS2=ON MS3=* *MS3 ON=Smooth Dimming, MS3 OFF=Step Dimming		L1: Dimming L2, L3: Independent
MODE 4	MS1=ON MS2=ON MS3=* *MS3 ON=Smooth Dimming, MS3 OFF=Step Dimming		L1, L2: Dimming L3: Independent



Four modes allow for numerous dimming and non-dimming configurations.

Side-mounted DIP switches let you switch between modes before installation.

Color-coded push pin connectors make installation quick and simple.



These pictures are for reference only and depict a typical LVC-2000 installation. Many alternate luminaires and installations may exist. Please consult with local NEC Codes and other applicable agency listing requirements for specific installations requirements.

COMMON SPECIFICATIONS

Input Voltage	<ul style="list-style-type: none"> 120-277 VAC, 50/60 Hz 277 VAC, 5 A, General Use 277 VAC, 5 A, Ballast RMS current should not exceed 5 amps per load
Load Type	<ul style="list-style-type: none"> 277 VAC, 5 A, General Use per Load 277 VAC, 5 A, Ballast per Load Maximum total device current: 10 A +10% to accommodate brief intermittent line swells
Output Voltage	120-277 VAC, 50/60 Hz
Output Devices	Three 30 amp relays driven by low voltage microcontroller, ESD protected
Low Voltage Momentary Switch Requirements	Dry contacts, momentary, normally open, capable of switching 5 VDC @ 0.5 mA
Power Supply Classification	UL listed switch mode power supply
Ambient Operating Temperature Range	50° to 176° F (10° to 80° C)
External wires	<ul style="list-style-type: none"> White/Black: 12-16 AWG, solid or coarse stranded Pink, Yellow, Orange, Green: 12-18 AWG, solid or coarse stranded All other wires: 12-24 AWG, solid or coarse stranded For use only with 75° C copper wire, insulation stripped back 5/16" Ensure that wire used exceeds corresponding voltage ratings
Mounting	<ul style="list-style-type: none"> Mounts in a lighting fixture, ceiling, or headwall May be mounted in a five gang masonry box with physical separation between high and low voltage
Housing	.032" Galvanized Zinc-Plated Steel
Dimensions	9" with tabs (L) x 1.90" (W) x 1.10" (H)
Warranty	Three Years
Regulatory Listings and Compliance	<ul style="list-style-type: none"> UL/C-UL Listed to UL 508 Compliant with FCC, Title 47 CFR 15 – Class B This device complies with Part 15 of the FCC Rules. Operation is subject to the following two conditions: (1) This device may not cause harmful interference, and (2) this device must accept any interference received including interference that may cause undesired operation. Compliant with CAN ICES-3 (N/NMB-3(B)) RoHS compliant

UNIQUE SPECIFICATIONS

	LVC-2000-001	LVC-2000-004	LVC-2000-006
Lamp Type	<ul style="list-style-type: none"> LED with dimming driver Fluorescent with ballast (ballast must have a power factor of 0.9 or greater) 	<ul style="list-style-type: none"> LED with dimming driver 	<ul style="list-style-type: none"> LED with dimming driver
Dimming Control	<ul style="list-style-type: none"> Current sourcing 0-10V step and smooth One direction smooth or step dimming from 100% to off 	<ul style="list-style-type: none"> Current sourcing 0-10V step and smooth Bi-directional smooth dimming from 25% to 100% with quick on/off One direction step dimming from 100% to off 	<ul style="list-style-type: none"> Current sourcing 0-10V step and smooth Bi-directional smooth dimming from 100% to off, or one direction step dimming from 100% to off Exam light override (turns two loads to maximum brightness)

NON-DIMMING LOW VOLTAGE CONTROLLER

FOR LIGHTING FIXTURE APPLICATIONS



LC-060

- ▣ For mounting into lighting fixtures or a five gang masonry box
- ▣ Can be used to operate high-voltage circuits such as lights, electric doors, blinds, and drapes
- ▣ For use with fluorescent, LED, and other lamp types
- ▣ Can be controlled from a pillow speaker, bed side rail, or wall switch with normally-open momentary dry contacts
- ▣ Controls two loads independently (on/off), or two loads sequentially (on/off)
- ▣ Safe for use near medical equipment that is sensitive to electromagnetic noise



This picture is for reference only and depict typical installations. Please consult with local NEC Codes and other applicable agency listing requirements for specific installations requirements.

SPECIFICATIONS

Input Voltage	<ul style="list-style-type: none">▣ 120-277 VAC, 50/60 Hz▣ 277 VAC, 5 A, General Use▣ 277 VAC, 5 A, Ballast▣ RMS current should not exceed 5 amps per load
Load Type	<ul style="list-style-type: none">▣ 277 VAC, 5 A, General Use per Load▣ 277 VAC, 5 A, Ballast per Load▣ Maximum total device current: 10 A +10% to accommodate brief intermittent line swells
Lamp Type	Fluorescent, LED, and other lamp types
Output Voltage	120-277 VAC, 50/60 Hz
Output Devices	Two 10 amp relays driven by low voltage microcontroller, ESD protected.
Dimming Control	NA
Low Voltage Momentary Switch Requirements	Dry contacts, momentary, normally open, capable of switching 5 VDC @ 0.5 mA
Power Supply Classification	Isolation from line voltage via a Class 2 transformer
Ambient Operating Temperature Range	32° to 140° F (0° to 60° C)
External wires	White/Black: 16 AWG stranded, all other wires: 18 AWG stranded
Mounting	<ul style="list-style-type: none">▣ Mounts in a lighting fixture, ceiling, or headwall▣ May be mounted in a five gang masonry box with physical separation between high and low voltage
Housing	.032" Galvanized Zinc-Plated Steel
Dimensions	6.75" with tabs (L) x 1.90" (W) x 1.20" (H)
Warranty	Three Years
Regulatory Listings and Compliance	UL/C-UL Listed to UL 508 Compliant with FCC, Title 47 CFR 15 – Class B RoHS compliant

NON-DIMMING LOW VOLTAGE CONTROLLER

FOR HEADWALL AND CEILING APPLICATIONS



LVC-3000-001

- For mounting into walls or ceilings in a two gang masonry box
- Can be used to operate high-voltage circuits such as lights, electric doors, blinds, and drapes
- For use with fluorescent, LED, and other lamp types
- Can be controlled from a pillow speaker, bed side rail, or wall switch with normally-open momentary dry contacts
- Controls two loads independently (on/off), or two loads sequentially (on/off)
- Safe for use near medical equipment that is sensitive to electromagnetic noise



This picture is for reference only and depict typical installations. Please consult with local NEC Codes and other applicable agency listing requirements for specific installations requirements.

SPECIFICATIONS

Input Voltage	<ul style="list-style-type: none"> ■ 120-277 VAC, 50/60 Hz ■ 277 VAC, 5 A, General Use ■ 277 VAC, 5 A, Ballast ■ RMS current should not exceed 5 amps per load
Load Type	<ul style="list-style-type: none"> ■ 277 VAC, 5 A, General Use per Load ■ 277 VAC, 5 A, Ballast per Load ■ Maximum total device current: 10 A +10% to accommodate brief intermittent line swells
Lamp Type	Fluorescent, LED, and other lamp types
Output Voltage	120-277 VAC, 50/60 Hz
Output Devices	Two 10 amp relays driven by low voltage microcontroller, ESD protected
Dimming Control	NA
Low Voltage Momentary Switch Requirements	Dry contacts, momentary, normally open, capable of switching 5 VDC @ 0.5 mA
Power Supply Classification	UL listed switch mode power supply
Ambient Operating Temperature Range	40° to 105° F (5° to 40° C)
External wires	White/Black: 16 AWG stranded • All other wires: 18 AWG stranded
Mounting	3.5" deep masonry box, two gang minimum
Housing	.032" Galvanized Zinc-Plated Steel
Dimensions	3.5" (L) x 3.5" (W) x 3.8" (D)
Warranty	Three Years
Regulatory Listings and Compliance	UL/C-UL Listed to UL 508 Compliant with FCC, Title 47 CFR 15 — Class B RoHS compliant

LOW VOLTAGE LIGHTING CONTROLLER WALL SWITCHES

FOR HEADWALL AND CEILING APPLICATIONS

Curbell's Low Voltage Controller Wall Switch is designed to allow the clinical staff to easily access patient room lighting. It can be placed at the entrance of the room, next to the patient's bed, or anywhere in the patient room that is convenient for the staff. Different control configurations can be used together to create customized access without needlessly complicating the installation. The low voltage switch is wired in parallel with the pillow speaker, handheld pendants, bed side rail, and/or Curbell Remote Entertainment Station to the low voltage side of the Curbell low voltage controller.

- ▣ Provides easy access for clinicians
- ▣ Controls up to five separate lights/loads
- ▣ Seamlessly integrates with any nurse call system
- ▣ Allows staff to dim the lights (when used with a Curbell dimming LVC)
- ▣ Quick on/off of any light/load
- ▣ Two year warranty

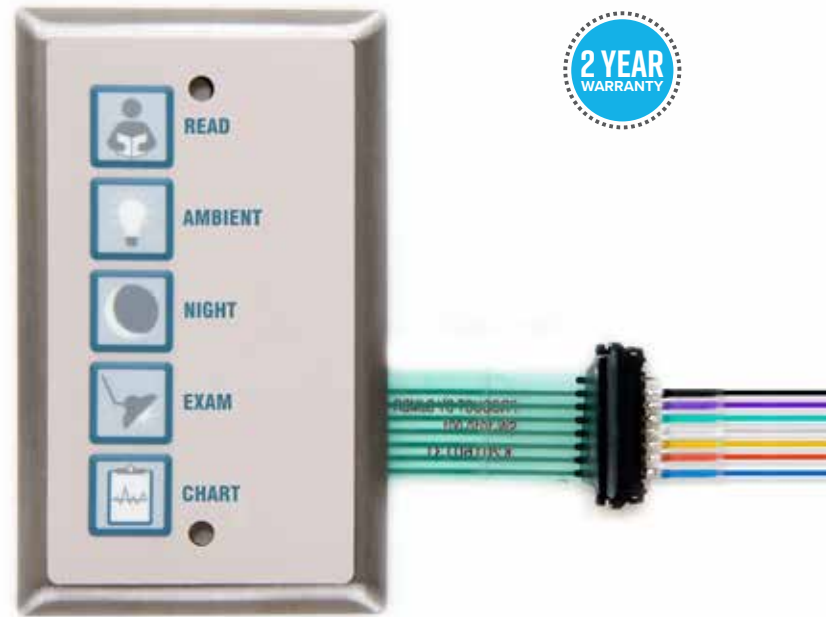

WPA-1000-001

CONFIGURATIONS

Shown here are our most popular configurations, but many more are available, and we can also create a custom configuration to meet your requirements. Contact your Curbell representative for more information.



WPA-1000-005

WPA-1000-006

WPA-1000-007



WPA-1000-008

WPA-1000-010

WPA-1000-013

MODEL	CONFIGURATION	PART #	PRICE
WPA-1000-001	Read,Ambient,Night,Exam,Chart	21190	\$69.96
WPA-1000-003	Read,Night,Ambient,Exam	21191	\$69.96
WPA-1000-004	Read,Ambient,Night,Exam	21192	\$69.96
WPA-1000-005	Read,Ambient,Night	21193	\$69.96
WPA-1000-006	Read,Ambient	21194	\$69.96
WPA-1000-007	Ambient	21195	\$69.96
WPA-1000-008	Exam	21270	\$69.96
WPA-1000-010	Ambient,Read,Exam	21794	\$69.96
WPA-1000-011	Ambient,Night	22166	\$69.96
WPA-1000-012	Exam,Ambient	22323	\$69.96
WPA-1000-013	Read,Ambient,Sink	22325	\$69.96
WPA-1000-014	Sink	22326	\$69.96
WPA-1000-015	Entry,Ceiling,Wall,Night	23379	\$69.96
WPA-1000-016	Shade up,Shade Down	23401	\$69.96
WPA-1000-017	Read,Ambient,Exam	24800	\$69.96

! TO CONTROL LIGHTS, AS WELL AS THE TELEVISION, SEE OUR REMOTE ENTERTAINMENT STATION ON PAGE 18



PILLOW SPEAKER AND REPLACEMENT PARTS PRICING

The following pages list replacement parts and repair services for nurse call systems, listed by nurse call system manufacturer. If you don't see what you're looking for, or if you have any questions, call your Curbell Medical sales representative at 1-800-235-7500.

Amplion Communications®	58
Ascom/GE	59-60
Austco	61
Critical Alert/Intego/Wescom®	62
Dukane®	63-66
Executone®	67-69
Fisher Berkeley	70
HCE/Sylvania®	71
Hillrom®	72-73
Intercall Systems®	74
Jeron®	75-77
Rauland®	78-80
SimplexGrinnell®	81
TekTone®	82-83
West-Com	84-86
Zettler®	87-88
Applications without Nurse Call	89-90
Universal Breakaway	90
Pillow Speaker Parts	91

REPLACEMENT PILLOW SPEAKERS AND ACCESSORIES FOR Amplion Alert



PILLOW SPEAKERS

TYPE	FEATURES	DIGITAL VOLUME MODEL #	PRICE	ANALOG VOLUME MODEL #	PRICE
Gen4+ DirectAccess	Nurse, TV, 0-9 Keypad	5C304-0-DV	\$136.95	5C304-0-AV	\$141.95
	Nurse, TV, 0-9 Keypad, 1 Light	5C304-1-DV	\$138.95	5C304-1-AV	\$143.95
	Nurse, TV, 0-9 Keypad, 2 Lights	5C304-2-DV	\$140.95	5C304-2-AV	\$145.95
	Nurse, TV, 0-9 Keypad, Pain/Toilet/Water	5C304-PTW-DV	\$142.95	5C304-PTW-AV	\$147.95
	Nurse, TV, 0-9 Keypad, 1 Light, Pain/Toilet/Water	5C304-4-DV	\$144.95	5C304-3-AV	\$149.95
	Nurse, TV, 0-9 Keypad, 2 Lights, Pain/Toilet/Water	5C304-5-DV	\$146.95	5C304-4-AV	\$151.95
	Nurse, TV, 0-9 Keypad, 2 Lights, Pain/Toilet/Water/IV	5C304-PTWI-DV	\$148.95	5C304-PTWI-AV	\$153.95
Gen4 Digital	Nurse, TV	4D304-0-DV	\$131.95	4D304-0-AV	\$136.95
	Nurse, TV, 1 Light	4D304-1-DV	\$133.95	4D304-1-AV	\$138.95
	Nurse, TV, 2 Lights	4D304-2-DV	\$135.95	4D304-2-AV	\$140.95

NOTE: Call for complete pillow speaker part numbers.

Part numbers are based on standard wiring and 8 ft. cable length. Call for additional options including ear jack, alternate cable length, and auxiliaries.

PILLOW SPEAKER REPAIR

DESCRIPTION	PRICE
Repair of Gen4+ DirectAccess, Gen4 Digital, or Gen4 Interactive	CALL

PILLOW SPEAKER TESTER

DESCRIPTION	MODEL #	PART #	PRICE
Tester with one module	CT-300	6333	\$395.95
Additional module for this nurse call system	CALL	CALL	CALL

PILLOW SPEAKER REPLACEMENT CABLES

DESCRIPTION	LENGTH	MODEL #	PART #	PRICE
Replacement cable for Gen4 and Gen4+ pillow speakers	8'	CAD-3000	CALL	\$40.95

CALL CORDS (1/4" accessories may require an adaptor)

DESCRIPTION	LENGTH	1/4" PLUG MODEL #	PART #	PRICE
Gen4 Sealed Call Cord	8'	SCC-0101-080-N	13259	\$17.20
Gen4 Sealed Call Cord	12'	SCC-0101-120-N	13261	\$19.20
Classic Call Cord	8'	CC96-010	5822	\$14.95
Classic Call Cord	12'	CC144-010	5733	\$16.95
BreathCall	9'	GEB-010	7380	\$143.12
E-Z Call	10'	GEE-010	7402	\$69.95
Mechanical Pad	10'	GEM-0000-AGY	7407	\$43.95
PadCall	8'	GEA-030	7351	\$53.25
PressCall	8'	GEP-140	7441	\$41.75

ADAPTORS (see page 33 for descriptions of adaptor types)

TYPE	PLUG STYLE	RECEPTACLE 1	RECEPTACLE 2	RECEPTACLE 3	MODEL #	PART #	PRICE
Box	15-Pin	15 Pin	1/4" jack (nurse call)	–	ADP-1506F-101	21077	\$93.95

DUMMY PLUGS

DESCRIPTION	MODEL #	PART #	PRICE
1/4" plug, metal plug, overmolded, 6" poly cord	DP-020	6834	\$5.25

REPLACEMENT PILLOW SPEAKERS AND ACCESSORIES FOR

Ascom®/GE Telligence® 5

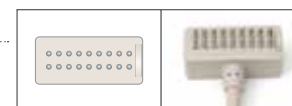

PILLOW SPEAKERS

TYPE	FEATURES	DIGITAL VOLUME MODEL #	PRICE	ANALOG VOLUME MODEL #	PRICE
Gen4+ DirectAccess	Nurse, TV, 0-9 Keypad	5C370-0-DV	\$101.95	5C370-0-AV	\$106.95
	Nurse, TV, 0-9 Keypad, 1 Light	5C370-1-DV	\$103.95	5C370-1-AV	\$108.95
	Nurse, TV, 0-9 Keypad, 2 Lights	5C370-2-DV	\$105.95	5C370-2-AV	\$110.95
Gen4 Digital	Nurse, TV	4D370-0-DV	\$92.95	4D370-0-AV	\$97.95
	Nurse, TV, 1 Light	4D370-1-DV	\$94.95	4D370-1-AV	\$99.95
	Nurse, TV, 2 Lights	4D370-2-DV	\$96.95	4D370-2-AV	\$101.95

NOTE: Call for complete pillow speaker part numbers.

Part numbers are based on standard wiring and 8 ft. cable length. Call for additional options including ear jack, alternate cable length, and auxiliaries.

PILLOW SPEAKER REPAIR

DESCRIPTION	PRICE
Repair of Gen4+ DirectAccess, Gen4 Digital, or Gen4 Interactive	CALL

PILLOW SPEAKER TESTER

DESCRIPTION	MODEL #	PART #	PRICE
Tester with one module	CT-300	6333	\$395.95
Additional module for this nurse call system	CALL	CALL	\$95.95

PILLOW SPEAKER REPLACEMENT CABLES

DESCRIPTION	LENGTH	MODEL #	PART #	PRICE
Replacement cable for Gen4 and Gen4+ pillow speakers	8'	CAD-3701	CALL	\$37.95

CALL CORDS (1/4" ACCESSORIES MAY REQUIRE AN ADAPTOR)

DESCRIPTION	LENGTH	18-PIN MODEL #	PART #	PRICE	1/4" PLUG MODEL #	PART #	PRICE
Gen4 Sealed Call Cord	8'	SCC-3701-820-U	13281	\$43.20	SCC-0101-080-U	13260	\$17.20
Gen4 Sealed Call Cord	12'	SCC-3701-C20-U	13283	\$47.20	SCC-0101-120-U	13262	\$19.20
Classic Call Cord	8'	-	-	-	CC96-010	5822	\$14.95
Classic Call Cord	12'	CC144-112	5742	\$44.95	CC144-010	5733	\$16.95
BreathCall	9'	-	-	-	GEB-010	7380	\$143.12
E-Z Call	10'	-	-	-	GEE-010	7402	\$69.95
Mechanical Pad	10'	GEM-477	7433	\$48.95	GEM-0000-AGY	7407	\$43.95
PadCall	8'	GEA-181	7369	\$76.24	GEA-030	7351	\$53.25
PressCall	8'	-	-	-	GEP-140	7441	\$41.75

ADAPTORS (see page 33 for descriptions of adaptor types)

TYPE	PLUG STYLE	RECEPTACLE 1	RECEPTACLE 2	RECEPTACLE 3	MODEL #	PART #	PRICE
Box	18-Pin	18-Pin	1/4" jack (nurse call)	1/4" jack (TV)	ADP-1802-103	3354	\$121.95
Box	18-Pin	18-Pin	18-Pin	-	ADP-1802-104	3355	\$126.95
Conversion	18-Pin	18-Pin	1/4" jack (nurse call)	-	AD-185	3241	\$19.95

DUMMY PLUGS

DESCRIPTION	MODEL #	PART #	PRICE
1/4" plug, metal plug, overmolded, 6" poly cord	DP-020	6834	\$5.25
18-Pin, Pins 8 and 10 Jumped, 6" Poly Cord	DPG-1802-011	6874	\$14.95

REPLACEMENT PILLOW SPEAKERS AND ACCESSORIES FOR

Ascom® Telligence® 6



PILLOW SPEAKERS

TYPE	FEATURES	DIGITAL VOLUME MODEL #	PRICE	ANALOG VOLUME MODEL #	PRICE
Gen4+ DirectAccess	Nurse, TV, 0-9 Keypad	5C430-0-DV	\$194.95	5C430-0-AV	\$199.95
	Nurse, TV, 0-9 Keypad, 1 Light	5C430-1-DV	\$196.95	5C430-1-AV	\$201.95
	Nurse, TV, 0-9 Keypad, 2 Lights	5C430-2-DV	\$198.95	5C430-2-AV	\$203.95
	Nurse, TV, 0-9 Keypad, WT/PN/TL	5C430-WPT-DV	\$204.95	5C430-0-AV	\$209.95
	Nurse, TV, 0-9 Keypad, 1 Light, WT/PN/TL	5C430-4-DV	\$206.95	5C430-1-AV	\$211.95
	Nurse, TV, 0-9 Keypad, 2 Lights, WT/PN/TL	5C430-5-DV	\$208.95	5C430-2-AV	\$213.95
Gen4 Digital	Nurse, TV	4D430-0-DV	\$184.95	4D430-0-AV	\$189.95
	Nurse, TV, 1 Light	4D430-1-DV	\$186.95	4D430-1-AV	\$191.95
	Nurse, TV, 2 Lights	4D430-2-DV	\$188.95	4D430-2-AV	\$193.95

NOTE: Call for complete pillow speaker part numbers.

Part numbers are based on standard wiring and 8 ft. cable length. Call for additional options including ear jack, alternate cable length, and auxiliaries.

PILLOW SPEAKER REPAIR

DESCRIPTION	PRICE
Repair of Gen4+ DirectAccess, Gen4 Digital, or Gen4 Interactive	CALL

PILLOW SPEAKER REPLACEMENT CABLES

DESCRIPTION	LENGTH	MODEL #	PART #	PRICE
Replacement cable for Gen4 and Gen4+ pillow speakers	8'	CAD-4510	CALL	\$82.95

CALL CORDS (1/4" accessories may require an adaptor)

DESCRIPTION	LENGTH	6-PIN MAGNETIC MODEL #	PART #	PRICE	1/4" PLUG MODEL #	PART #	PRICE
Gen4 Sealed Call Cord	8'	—	—	—	SCC-0101-080-U	13260	\$17.20
Gen4 Sealed Call Cord	12'	SCC-4506-121-N	25753	\$46.95	SCC-0101-120-U	13262	\$19.20
Classic Call Cord	8'	—	—	—	CC96-010	5822	\$14.95
Classic Call Cord	12'	—	—	—	CC144-010	5733	\$16.95
BreathCall	9'	—	—	—	GEB-010	7380	\$143.12
E-Z Call	10'	—	—	—	GEE-010	7402	\$69.95
Mechanical Pad	10'	—	—	—	GEM-0000-AGY	7407	\$43.95
PadCall	8'	—	—	—	GEA-030	7351	\$53.25
PressCall	8'	—	—	—	GEP-140	7441	\$41.75

REPLACEMENT PILLOW SPEAKERS AND ACCESSORIES FOR

Austco® Tacera IP, Medicom



PILLOW SPEAKERS

TYPE	FEATURES	DIGITAL VOLUME MODEL #	PRICE	ANALOG VOLUME MODEL #	PRICE
Gen4+ DirectAccess	Nurse, TV, 0-9 Keypad	5C19A-0-DV	\$102.95	5C19A-0-AV	\$107.95
	Nurse, TV, 0-9 Keypad, 1 Light	5C19A-1-DV	\$104.95	5C19A-1-AV	\$109.95
	Nurse, TV, 0-9 Keypad, 2 Lights	5C19A-2-DV	\$106.95	5C19A-2-AV	\$111.95
Gen4 Digital	Nurse, TV	4D19A-0-DV	\$89.95	4D19A--0-AV	\$94.95
	Nurse, TV, 1 Light	4D19A--1-DV	\$91.95	4D19A--1-AV	\$96.95
	Nurse, TV, 2 Lights	4D19A--2-DV	\$93.95	4D19A--2-AV	\$98.95

NOTE: Call for complete pillow speaker part numbers.

Part numbers are based on standard wiring and 8 ft. cable length. Call for additional options including ear jack, alternate cable length, and auxiliaries.

PILLOW SPEAKER REPAIR

DESCRIPTION	PRICE
Repair of Gen4+ DirectAccess, Gen4 Digital, or Gen4 Interactive	CALL

PILLOW SPEAKER TESTER

DESCRIPTION	MODEL #	PART #	PRICE
Tester with one module	CT-300	6333	\$395.95
Additional module for this nurse call system	CALL	CALL	\$75.95

PILLOW SPEAKER REPLACEMENT CABLES

DESCRIPTION	LENGTH	MODEL #	PART #	PRICE
Replacement cable for Gen4 and Gen4+ pillow speakers	8'	CAD-1900	CALL	\$30.95

PILLOW SPEAKER BREAKAWAY CABLES

DESCRIPTION	LENGTH	MODEL #	PART #	PRICE
8-pin DIN breakaway cable with clamp	8"	JUP-1901-008	15084	\$19.95
	24"	JUP-1901-024	20083	\$24.95

CALL CORDS (1/4" accessories may require an adaptor)

DESCRIPTION	LENGTH	1/4" PLUG MODEL #	PART #	PRICE
Gen4 Sealed Call Cord	8'	SCC-0101-080-U	13260	\$17.20
Gen4 Sealed Call Cord	12'	SCC-0101-120-U	13262	\$19.20
Classic Call Cord	8'	CC96-010	5822	\$14.95
Classic Call Cord	12'	CC144-010	5733	\$16.95
BreathCall	9'	GEB-010	7380	\$143.12
E-Z Call	10'	GEE-010	7402	\$69.95
Mechanical Pad	10'	GEM-0000-AGY	7407	\$43.95
PadCall	8'	GEA-030	7351	\$53.25
PressCall	8'	GEP-140	7441	\$41.75

ADAPTORS (see page 33 for descriptions of adaptor types)

TYPE	PLUG STYLE	RECEPTACLE 1	RECEPTACLE 2	RECEPTACLE 3	MODEL #	PART #	PRICE
Box	8-Pin DIN	8-Pin DIN	8-Pin DIN	1/4" jack (nurse call)	ADP-0800-127	3303	\$83.95
Box	8-Pin DIN	8-Pin DIN	8-Pin DIN	–	ADP-0800-128	3304	\$72.95
Box	8-Pin DIN	8-Pin DIN	1/4" jack (nurse call)	–	ADP-0800-129	3305	\$79.95
Box	8-Pin DIN	8-Pin DIN	1/4" jack (nurse call)	1/4" jack (TV)	ADP-0800-130	3306	\$78.95

DUMMY PLUGS

DESCRIPTION	MODEL #	PART #	PRICE
1/4" plug, metal plug, overmolded, 6" poly cord	DP-020	6834	\$5.25
8-Pin DIN	DP-060	6838	\$8.95

REPLACEMENT PILLOW SPEAKERS AND ACCESSORIES FOR Critical Alert/Wescom/Intego® SPS101, System 200, 1000/3000

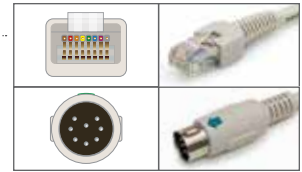

PILLOW SPEAKERS

TYPE	FEATURES	DIGITAL VOLUME MODEL #	PRICE	ANALOG VOLUME MODEL #	PRICE
Gen4+ DirectAccess	Nurse, TV, 0-9 Keypad	5C215-0-DV	\$92.95	5C215-0-AV	\$97.95
	Nurse, TV, 0-9 Keypad, 1 Light	5C215-1-DV	\$94.95	5C215-1-AV	\$99.95
	Nurse, TV, 0-9 Keypad, 2 Lights	5C215-2-DV	\$96.95	5C215-2-AV	\$101.95
	Nurse, TV, 0-9 Keypad	5C19F-0-DV (8-Pin DIN)	\$102.95	5C19F-0-AV (8-Pin DIN)	\$107.95
	Nurse, TV, 0-9 Keypad, 1 Light	5C19F-1-DV (8-Pin DIN)	\$104.95	5C19F-1-AV (8-Pin DIN)	\$109.95
	Nurse, TV, 0-9 Keypad, 2 Lights	5C19F-2-DV (8-Pin DIN)	\$106.95	5C19F-2-AV (8-Pin DIN)	\$111.95
Gen4 Digital	Nurse, TV	4D215-0-DV	\$86.95	4D215-0-AV	\$91.95
	Nurse, TV, 1 Light	4D215-1-DV	\$88.95	4D215-1-AV	\$93.95
	Nurse, TV, 2 Lights	4D215-2-DV	\$90.95	4D215-2-AV	\$95.95
	Nurse, TV	4D19F-0-DV (8-Pin DIN)	\$89.95	4D19F-0-AV (8-Pin DIN)	\$94.95
	Nurse, TV, 1 Light	4D19F-1-DV (8-Pin DIN)	\$91.95	4D19F-1-AV (8-Pin DIN)	\$96.95
	Nurse, TV, 2 Lights	4D19F-2-DV (8-Pin DIN)	\$93.95	4D19F-2-AV (8-Pin DIN)	\$98.95

NOTE: Call for complete pillow speaker part numbers. 5C19F and 4D19F pillow speakers must be used with pillow speaker breakaway cable (see JUP-1065-010 below). Part numbers are based on standard wiring and 8 ft. cable length. Call for additional options including ear jack, alternate cable length, and auxiliaries.

PILLOW SPEAKER REPAIR

DESCRIPTION	PRICE
Repair of Gen4+ DirectAccess, Gen4 Digital, or Gen4 Interactive	CALL

PILLOW SPEAKER TESTER

DESCRIPTION	MODEL #	PART #	PRICE
Tester with one module	CT-300	6333	\$395.95
Additional module for this nurse call system	CALL	CALL	\$85.95

PILLOW SPEAKER REPLACEMENT CABLES

DESCRIPTION	LENGTH	MODEL #	PART #	PRICE
Replacement cable for Gen4 and Gen4+ pillow speakers	8'	CAD-2100	CALL	\$28.95

PILLOW SPEAKER BREAKAWAY CABLES

DESCRIPTION	LENGTH	MODEL #	PART #	PRICE
8-Pin Modular (male) to 8-Pin DIN (female) breakaway cable with clamp	10"	JUP-1065-010	26124	\$19.95

CALL CORDS (1/4" accessories may require an adaptor)

DESCRIPTION	LENGTH	8-PIN MODULAR MODEL #	PART #	PRICE	1/4" PLUG MODEL #	PART #	PRICE
Gen4 Sealed Call Cord	8'	SCC-2101-080-N	13272	\$22.20	SCC-0101-080-N	13259	\$17.20
Gen4 Sealed Call Cord	12'	-	-	-	SCC-0101-120-N	13261	\$19.20
Classic Call Cord	8'	CC96-080	5835	\$19.95	CC96-010	5822	\$14.95
Classic Call Cord	12'	-	-	-	CC144-010	5733	\$16.95
BreathCall	9'	GEB-170	7391	\$173.42	GEB-010	7380	\$143.12
E-Z Call	10'	-	-	-	GEE-010	7402	\$69.95
Mechanical Pad	10'	GEM-471	7430	\$47.95	GEM-0000-AGY	7407	\$43.95
PadCall	8'	GEA-145	7364	\$76.24	GEA-030	7351	\$53.25
PressCall	8'	GEP-310	7453	\$64.74	GEP-140	7441	\$41.75

ADAPTORS (see page 33 for descriptions of adaptor types)

TYPE	PLUG STYLE	RECEPTACLE 1	RECEPTACLE 2	RECEPTACLE 3	MODEL #	PART #	PRICE
Box	8-Pin Modular	8-Pin Modular	1/4" jack (nurse call)	-	ADP-0808-101	3322	\$77.95
Box	8-Pin Modular	8-Pin Modular	1/4" jack (nurse call)	1/4" jack (TV)	ADP-0808-102	3323	\$87.95
Box	8-Pin Modular	8-Pin Modular	8-Pin Modular	-	ADP-0808-103	3324	\$91.95
Conversion	8-Pin Modular	1/4" jack (nurse call)	-	-	AD-030	3212	\$30.95

DUMMY PLUGS

DESCRIPTION	MODEL #	PART #	PRICE
1/4" plug, metal plug, overmolded, 6" poly cord	DP-020	6834	\$5.25
8-Pin Modular, 6" Poly Cord	DP-082	6844	\$8.95

REPLACEMENT PILLOW SPEAKERS AND ACCESSORIES FOR

Dukane® System 2000, 2010, 2020, 2030

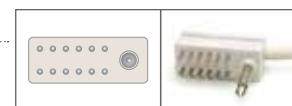

PILLOW SPEAKERS

TYPE	FEATURES	DIGITAL VOLUME MODEL #	PRICE	ANALOG VOLUME MODEL #	PRICE
Gen4+ DirectAccess	Nurse, TV, 0-9 Keypad	5C110-0-DV	\$99.95	5C110-0-AV	\$104.95
	Nurse, TV, 0-9 Keypad, 1 Light	5C110-1-DV	\$101.95	5C110-1-AV	\$106.95
	Nurse, TV, 0-9 Keypad, 2 Lights	5C110-2-DV	\$103.95	5C110-2-AV	\$108.95
Gen4 Digital	Nurse, TV	4D110-0-DV	\$90.95	4D110-0-AV	\$95.95
	Nurse, TV, 1 Light	4D110-1-DV	\$92.95	4D110-1-AV	\$97.95
	Nurse, TV, 2 Lights	4D110-2-DV	\$94.95	4D110-2-AV	\$99.95

NOTE: Call for complete pillow speaker part numbers.

Part numbers are based on standard wiring and 8 ft. cable length. Call for additional options including ear jack, alternate cable length, and auxiliaries.

PILLOW SPEAKER REPAIR

DESCRIPTION	PRICE
Repair of Gen4+ DirectAccess, Gen4 Digital, or Gen4 Interactive	CALL

PILLOW SPEAKER TESTER

DESCRIPTION	MODEL #	PART #	PRICE
Tester with one module	CT-300	6333	\$395.95
Additional module for this nurse call system	CALL	CALL	\$86.95

PILLOW SPEAKER REPLACEMENT CABLES

DESCRIPTION	LENGTH	MODEL #	PART #	PRICE
Replacement cable for Gen4 and Gen4+ pillow speakers	8'	CAD-1100	CALL	\$36.95

CALL CORDS (1/4" accessories may require an adaptor)

DESCRIPTION	LENGTH	MODEL #	PART #	PRICE
Gen4 Sealed Call Cord	8'	SCC-0101-080-N	13259	\$17.20
Gen4 Sealed Call Cord	12'	SCC-0101-120-N	13261	\$19.20
Classic Call Cord	8'	CC96-010	5822	\$14.95
Classic Call Cord	12'	CC144-010	5733	\$16.95
BreathCall	9'	GEB-010	7380	\$143.12
E-Z Call	10'	GEE-010	7402	\$69.95
Mechanical Pad	10'	GEM-0000-AGY	7407	\$43.95
PadCall	8'	GEA-030	7351	\$53.25
PressCall	8'	GEP-140	7441	\$41.75

ADAPTORS (see page 33 for descriptions of adaptor types)

TYPE	PLUG STYLE	RECEPTACLE 1	RECEPTACLE 2	RECEPTACLE 3	MODEL #	PART #	PRICE
Box	13-Pin	13 Pin Dukane/GE	1/4" jack (nurse call)	—	ADP-0413-101	3271	\$87.95
Box	13-Pin	13 Pin Dukane/GE	1/4" jack (nurse call)	1/4" (TV)	ADP-0413-106	3274	\$97.95

DUMMY PLUGS

DESCRIPTION	MODEL #	PART #	PRICE
1/4" plug, metal plug, overmolded, 6" poly cord	DP-020	6834	\$5.25

REPLACEMENT PILLOW SPEAKERS AND ACCESSORIES FOR Dukane® Procure 2000®, System 2070



PILLOW SPEAKERS

TYPE	FEATURES	DIGITAL VOLUME MODEL #	PRICE	ANALOG VOLUME MODEL #	PRICE
Gen4+ DirectAccess	Nurse, TV, 0-9 Keypad	5C120-0-DV	\$99.95	5C120-0-AV	\$104.95
	Nurse, TV, 0-9 Keypad, 1 Light	5C120-1-DV	\$101.95	5C120-1-AV	\$106.95
	Nurse, TV, 0-9 Keypad, 2 Lights	5C120-2-DV	\$103.95	5C120-2-AV	\$108.95
Gen4 Digital	Nurse, TV	4D120-0-DV	\$90.95	4D120-0-AV	\$95.95
	Nurse, TV, 1 Light	4D120-1-DV	\$92.95	4D120-1-AV	\$97.95
	Nurse, TV, 2 Lights	4D120-2-DV	\$94.95	4D120-2-AV	\$99.95

NOTE: Call for complete pillow speaker part numbers.

Part numbers are based on standard wiring and 8 ft. cable length. Call for additional options including ear jack, alternate cable length, and auxiliaries.

PILLOW SPEAKER REPAIR

DESCRIPTION	PRICE
Repair of Gen4+ DirectAccess, Gen4 Digital, or Gen4 Interactive	CALL

PILLOW SPEAKER TESTER

DESCRIPTION	MODEL #	PART #	PRICE
Tester with one module	CT-300	6333	\$395.95
Additional module for this nurse call system	CALL	CALL	\$86.95

PILLOW SPEAKER REPLACEMENT CABLES

DESCRIPTION	LENGTH	MODEL #	PART #	PRICE
Replacement cable for Gen4 and Gen4+ pillow speakers	8'	CAD-1200	CALL	\$35.95

CALL CORDS (1/4" accessories may require an adaptor)

DESCRIPTION	LENGTH	MODEL #	PART #	PRICE
Gen4 Sealed Call Cord	8'	SCC-0101-080-N	13259	\$17.20
Gen4 Sealed Call Cord	12'	SCC-0101-120-N	13261	\$19.20
Classic Call Cord	8'	CC96-010	5822	\$14.95
Classic Call Cord	12'	CC144-010	5733	\$16.95
BreathCall	9'	GEB-010	7380	\$143.12
E-Z Call	10'	GEE-010	7402	\$69.95
Mechanical Pad	10'	GEM-0000-AGY	7407	\$43.95
PadCall	8'	GEA-030	7351	\$53.25
PressCall	8'	GEP-140	7441	\$41.75

ADAPTORS (see page 33 for descriptions of adaptor types)

TYPE	PLUG STYLE	RECEPTACLE 1	RECEPTACLE 2	RECEPTACLE 3	MODEL #	PART #	PRICE
Box	17-Pin	17 Pin Dukane/GE	1/4" jack (nurse call)	—	ADP-0417-104	3280	\$90.95
Box	17-Pin	17 Pin Dukane/GE	1/4" jack (nurse call)	1/4" (TV)	ADP-0417-102	3279	\$100.95

DUMMY PLUGS

DESCRIPTION	MODEL #	PART #	PRICE
1/4" plug, metal plug, overmolded, 6" poly cord	DP-020	6834	\$5.25

REPLACEMENT PILLOW SPEAKERS AND ACCESSORIES FOR

Dukane® Procure 2000®, System 2070



PILLOW SPEAKERS

TYPE	FEATURES	DIGITAL VOLUME MODEL #	PRICE	ANALOG VOLUME MODEL #	PRICE
Gen4+ DirectAccess	Nurse, TV, 0-9 Keypad	5C130-0-DV	\$102.95	5C130-0-AV	\$107.95
	Nurse, TV, 0-9 Keypad, 1 Light	5C130-1-DV	\$104.95	5C130-1-AV	\$109.95
	Nurse, TV, 0-9 Keypad, 2 Lights	5C130-2-DV	\$106.95	5C130-2-AV	\$111.95
Gen4 Digital	Nurse, TV	4D130-0-DV	\$93.95	4D130-0-AV	\$98.95
	Nurse, TV, 1 Light	4D130-1-DV	\$95.95	4D130-1-AV	\$100.95
	Nurse, TV, 2 Lights	4D130-2-DV	\$97.95	4D130-2-AV	\$102.95

NOTE: Call for complete pillow speaker part numbers.

Part numbers are based on standard wiring and 8 ft. cable length. Call for additional options including ear jack, alternate cable length, and auxiliaries.

PILLOW SPEAKER REPAIR

DESCRIPTION	PRICE
Repair of Gen4+ DirectAccess, Gen4 Digital, or Gen4 Interactive	CALL

PILLOW SPEAKER TESTER

DESCRIPTION	MODEL #	PART #	PRICE
Tester with one module	CT-300	6333	\$395.95
Additional module for this nurse call system	CALL	CALL	\$86.95

PILLOW SPEAKER REPLACEMENT CABLES

DESCRIPTION	LENGTH	MODEL #	PART #	PRICE
Replacement cable for Gen4 and Gen4+ pillow speakers	8'	CAD-1300	CALL	\$37.95

CALL CORDS (1/4" accessories may require an adaptor)

DESCRIPTION	LENGTH	MODEL #	PART #	PRICE
Gen4 Sealed Call Cord	8'	SCC-0101-080-N	13259	\$17.20
Gen4 Sealed Call Cord	12'	SCC-0101-120-N	13261	\$19.20
Classic Call Cord	8'	CC96-010	5822	\$14.95
Classic Call Cord	12'	CC144-010	5733	\$16.95
BreathCall	9'	GEB-010	7380	\$143.12
E-Z Call	10'	GEE-010	7402	\$69.95
Mechanical Pad	10'	GEM-0000-AGY	7407	\$43.95
PadCall	8'	GEA-030	7351	\$53.25
PressCall	8'	GEP-140	7441	\$41.75

ADAPTORS (see page 33 for descriptions of adaptor types)

TYPE	PLUG STYLE	RECEPTACLE 1	RECEPTACLE 2	RECEPTACLE 3	MODEL #	PART #	PRICE
Box	19-pin	19 Pin Dukane/GE	1/4" jack	-	ADP-0419-102	3282	\$110.95

DUMMY PLUGS

DESCRIPTION	MODEL #	PART #	PRICE
1/4" plug, metal plug, overmolded, 6" poly cord	DP-020	6834	\$5.25

REPLACEMENT PILLOW SPEAKERS AND ACCESSORIES FOR Dukane® Procure 4000, 6000, System 2070



PILLOW SPEAKERS

TYPE	FEATURES	DIGITAL VOLUME MODEL #	PRICE	ANALOG VOLUME MODEL #	PRICE
Gen4+ DirectAccess	Nurse, TV, 0-9 Keypad	5C320-0-DV	\$105.95	5C320-0-AV	\$110.95
	Nurse, TV, 0-9 Keypad, 1 Light	5C320-1-DV	\$107.95	5C320-1-AV	\$112.95
	Nurse, TV, 0-9 Keypad, 2 Lights	5C320-2-DV	\$109.95	5C320-2-AV	\$114.95
Gen4 Digital	Nurse, TV	4D320-0-DV	\$96.95	4D320-0-AV	\$101.95
	Nurse, TV, 1 Light	4D320-1-DV	\$98.95	4D320-1-AV	\$103.95
	Nurse, TV, 2 Lights	4D320-2-DV	\$100.95	4D320-2-AV	\$105.95

NOTE: Call for complete pillow speaker part numbers.

Part numbers are based on standard wiring and 8 ft. cable length. Call for additional options including ear jack, alternate cable length, and auxiliaries.

PILLOW SPEAKER REPAIR

DESCRIPTION	PRICE
Repair of Gen4+ DirectAccess, Gen4 Digital, or Gen4 Interactive	CALL

PILLOW SPEAKER TESTER

DESCRIPTION	MODEL #	PART #	PRICE
Tester with one module	CT-300	6333	\$395.95
Additional module for this nurse call system	CALL	CALL	\$95.95

PILLOW SPEAKER REPLACEMENT CABLES

DESCRIPTION	LENGTH	MODEL #	PART #	PRICE
Replacement cable for Gen4 and Gen4+ pillow speakers	8'	CAD-3200	CALL	\$40.95

CALL CORDS (1/4" accessories may require an adaptor)

DESCRIPTION	LENGTH	18-PIN MODEL #	PART #	PRICE	1/4" PLUG MODEL #	PART #	PRICE
Gen4 Sealed Call Cord	8'	SCC-3701-820-U	13281	\$43.20	SCC-0101-080-U	13260	\$17.20
Gen4 Sealed Call Cord	12'	SCC-3701-C20-U	13283	\$47.20	SCC-0101-120-U	13262	\$19.20
Classic Call Cord	8'	-	-	-	CC96-010	5822	\$14.95
Classic Call Cord	12'	CC144-112	5742	\$44.95	CC144-010	5733	\$16.95
BreathCall	9'	-	-	-	GEB-010	7380	\$143.12
E-Z Call	10'	-	-	-	GEE-010	7402	\$69.95
Mechanical Pad	10'	GEM-477	7433	\$48.95	GEM-0000-AGY	7407	\$43.95
PadCall	8'	GEA-181	7369	\$76.24	GEA-030	7351	\$53.25
PressCall	8'	-	-	-	GEP-140	7441	\$41.75

ADAPTORS (see page 33 for descriptions of adaptor types)

TYPE	PLUG STYLE	RECEPTACLE 1	RECEPTACLE 2	RECEPTACLE 3	MODEL #	PART #	PRICE
Box	18-Pin	18-Pin	1/4" jack (nurse call)	1/4" jack (TV)	ADP-1802-103	3354	\$121.95
Box	18-Pin	18-Pin	18-Pin	-	ADP-1802-104	3355	\$126.95
Conversion	18-Pin	18-Pin	1/4" jack (nurse call)	-	AD-185	3241	\$19.95

DUMMY PLUGS

DESCRIPTION	MODEL #	PART #	PRICE
1/4" plug, metal plug, overmolded, 6" poly cord	DP-020	6834	\$5.25

REPLACEMENT PILLOW SPEAKERS AND ACCESSORIES FOR

Executone® Care/Com



PILLOW SPEAKERS

TYPE	FEATURES	DIGITAL VOLUME MODEL #	PRICE	ANALOG VOLUME MODEL #	PRICE
Gen4+ DirectAccess	Nurse, TV, 0-9 Keypad	5C050-0-DV	\$92.95	5C050-0-AV	\$97.95
	Nurse, TV, 0-9 Keypad, 1 Light	5C050-1-DV	\$94.95	5C050-1-AV	\$99.95
	Nurse, TV, 0-9 Keypad, 2 Lights	5C050-2-DV	\$96.95	5C050-2-AV	\$101.95
Gen4 Digital	Nurse, TV	4D050-0-DV	\$81.95	4D050-0-AV	\$86.95
	Nurse, TV, 1 Light	4D050-1-DV	\$83.95	4D050-1-AV	\$88.95
	Nurse, TV, 2 Lights	4D050-2-DV	\$85.95	4D050-2-AV	\$90.95

NOTE: Call for complete pillow speaker part numbers.

Part numbers are based on standard wiring and 8 ft. cable length. Call for additional options including ear jack, alternate cable length, and auxiliaries.

PILLOW SPEAKER REPAIR

DESCRIPTION	PRICE
Repair of Gen4+ DirectAccess, Gen4 Digital, or Gen4 Interactive	CALL

PILLOW SPEAKER TESTER

DESCRIPTION	MODEL #	PART #	PRICE
Tester with one module	CT-300	6333	\$395.95
Additional module for this nurse call system	CALL	CALL	\$88.95

PILLOW SPEAKER REPLACEMENT CABLES

DESCRIPTION	LENGTH	MODEL #	PART #	PRICE
Replacement cable for Gen4 and Gen4+ pillow speakers	8'	CAD-0500	CALL	\$26.95

CALL CORDS (1/4" accessories may require an adaptor)

DESCRIPTION	LENGTH	MODEL #	PART #	PRICE
Gen4 Sealed Call Cord	8'	SCC-0101-080-U	13260	\$17.20
Gen4 Sealed Call Cord	12'	SCC-0101-120-U	13262	\$19.20
Classic Call Cord	8'	CC96-010	5822	\$14.95
Classic Call Cord	12'	CC144-010	5733	\$16.95
BreathCall	9'	GEB-010	7380	\$143.12
E-Z Call	10'	GEE-010	7402	\$69.95
Mechanical Pad	10'	GEM-0000-AGY	7407	\$43.95
PadCall	8'	GEA-030	7351	\$53.25
PressCall	8'	GEP-140	7441	\$41.75

ADAPTORS (see page 33 for descriptions of adaptor types)

TYPE	PLUG STYLE	RECEPTACLE 1	RECEPTACLE 2	RECEPTACLE 3	MODEL #	PART #	PRICE
Box	7-Pin	7-Pin	7-Pin	–	ADP-0307-106	3251	\$100.95
Box	7-Pin	7-Pin	1/4" jack (nurse call)	–	ADP-0307-103	3248	\$76.95
Box	7-Pin	7-Pin	1/4" jack (nurse call)	1/4" jack (TV)	ADP-0307-109	3253	\$86.95

DUMMY PLUGS

DESCRIPTION	MODEL #	PART #	PRICE
1/4" plug, metal plug, overmolded, 6" poly cord	DP-020	6834	\$5.25

REPLACEMENT PILLOW SPEAKERS AND ACCESSORIES FOR

Executone® Futura



PILLOW SPEAKERS

TYPE	FEATURES	DIGITAL VOLUME MODEL #	PRICE	ANALOG VOLUME MODEL #	PRICE
Gen4+ DirectAccess	Nurse, TV, 0-9 Keypad	5C055-0-DV	\$92.95	5C055-0-AV	\$97.95
	Nurse, TV, 0-9 Keypad, 1 Light	5C055-1-DV	\$94.95	5C055-1-AV	\$99.95
	Nurse, TV, 0-9 Keypad, 2 Lights	5C055-2-DV	\$96.95	5C055-2-AV	\$101.95
Gen4 Digital	Nurse, TV	4D055-0-DV	\$81.95	4D055-0-AV	\$86.95
	Nurse, TV, 1 Light	4D055-1-DV	\$83.95	4D055-1-AV	\$88.95
	Nurse, TV, 2 Lights	4D055-2-DV	\$85.95	4D055-2-AV	\$90.95

NOTE: Call for complete pillow speaker part numbers.

Part numbers are based on standard wiring and 8 ft. cable length. Call for additional options including ear jack, alternate cable length, and auxiliaries.

PILLOW SPEAKER REPAIR

DESCRIPTION	PRICE
Repair of Gen4+ DirectAccess, Gen4 Digital, or Gen4 Interactive	CALL

PILLOW SPEAKER TESTER

DESCRIPTION	MODEL #	PART #	PRICE
Tester with one module	CT-300	6333	\$395.95
Additional module for this nurse call system	CALL	CALL	\$88.95

PILLOW SPEAKER REPLACEMENT CABLES

DESCRIPTION	LENGTH	MODEL #	PART #	PRICE
Replacement cable for Gen4 and Gen4+ pillow speakers	8'	CAD-0500	CALL	\$26.95

CALL CORDS (1/4" accessories may require an adaptor)

DESCRIPTION	LENGTH	MODEL #	PART #	PRICE
Gen4 Sealed Call Cord	8'	SCC-0101-080-U	13260	\$17.20
Gen4 Sealed Call Cord	12'	SCC-0101-120-U	13262	\$19.20
Classic Call Cord	8'	CC96-010	5822	\$14.95
Classic Call Cord	12'	CC144-010	5733	\$16.95
BreathCall	9'	GEB-010	7380	\$143.12
E-Z Call	10'	GEE-010	7402	\$69.95
Mechanical Pad	10'	GEM-0000-AGY	7407	\$43.95
PadCall	8'	GEA-030	7351	\$53.25
PressCall	8'	GEP-140	7441	\$41.75

ADAPTORS (see page 33 for descriptions of adaptor types)

TYPE	PLUG STYLE	RECEPTACLE 1	RECEPTACLE 2	RECEPTACLE 3	MODEL #	PART #	PRICE
Box	7-Pin Futura	7-Pin Futura	7-Pin Futura	–	ADP-0307-111	14299	\$100.95
Box	7-Pin Futura	7-Pin Futura	1/4" jack (nurse call)		ADP-0307-112	3254	\$76.95
Box	7-Pin Futura	7-Pin Futura	1/4" jack (nurse call)	1/4" jack (TV)	ADP-0307-113	3255	\$86.95

DUMMY PLUGS

DESCRIPTION	MODEL #	PART #	PRICE
1/4" plug, metal plug, overmolded, 6" poly cord	DP-020	6834	\$5.25

REPLACEMENT PILLOW SPEAKERS AND ACCESSORIES FOR

Executone® Lifesaver®

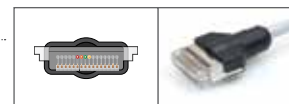

PILLOW SPEAKERS

TYPE	FEATURES	DIGITAL VOLUME MODEL #	PRICE	ANALOG VOLUME MODEL #	PRICE
Gen4+ DirectAccess	Nurse, TV, 0-9 Keypad	5C310-0-DV	\$118.95	5C310-0-AV	\$123.95
	Nurse, TV, 0-9 Keypad, 1 Light	5C310-1-DV	\$120.95	5C310-1-AV	\$125.95
	Nurse, TV, 0-9 Keypad, 2 Lights	5C310-2-DV	\$122.95	5C310-2-AV	\$127.95
Gen4 Digital	Nurse, TV	4D310-0-DV	\$109.95	4D310-0-AV	\$114.95
	Nurse, TV, 1 Light	4D310-1-DV	\$111.95	4D310-1-AV	\$116.95
	Nurse, TV, 2 Lights	4D310-2-DV	\$113.95	4D310-2-AV	\$118.95

NOTE: Call for complete pillow speaker part numbers.

Part numbers are based on standard wiring and 8 ft. cable length. Call for additional options including ear jack, alternate cable length, and auxiliaries.

PILLOW SPEAKER REPAIR

DESCRIPTION	PRICE
Repair of Gen4+ DirectAccess, Gen4 Digital, or Gen4 Interactive	CALL

PILLOW SPEAKER TESTER

DESCRIPTION	MODEL #	PART #	PRICE
Tester with one module	CT-300	6333	\$395.95
Additional module for this nurse call system	CALL	CALL	\$90.95

PILLOW SPEAKER REPLACEMENT CABLES

DESCRIPTION	LENGTH	MODEL #	PART #	PRICE
Replacement cable for Gen4 and Gen4+ pillow speakers	8'	CAD-3100	CALL	\$54.95

NOTE: Cables on all Lifesaver products are configured to E-Key style.

REPLACEMENT PILLOW SPEAKERS AND ACCESSORIES FOR Fisher Berkeley HP Series, MMC Series



PILLOW SPEAKERS

TYPE	FEATURES	DIGITAL VOLUME MODEL #	PRICE	ANALOG VOLUME MODEL #	PRICE
Gen4+ DirectAccess	Nurse, TV, 0-9 Keypad	5C300-0-DV	\$100.95	5C300-0-AV	\$105.95
	Nurse, TV, 0-9 Keypad, 1 Light	5C300-1-DV	\$102.95	5C300-1-AV	\$107.95
	Nurse, TV, 0-9 Keypad, 2 Lights	5C300-2-DV	\$104.95	5C300-2-AV	\$109.95
Gen4 Digital	Nurse, TV	4D300-0-DV	\$93.95	4D300-0-AV	\$98.95
	Nurse, TV, 1 Light	4D300-1-DV	\$95.95	4D300-1-AV	\$100.95
	Nurse, TV, 2 Lights	4D300-2-DV	\$97.95	4D300-2-AV	\$102.95

NOTE: Call for complete pillow speaker part numbers.

Part numbers are based on standard wiring and 8 ft. cable length. Call for additional options including ear jack, alternate cable length, and auxiliaries.

PILLOW SPEAKER REPAIR

DESCRIPTION	PRICE
Repair of Gen4+ DirectAccess, Gen4 Digital, or Gen4 Interactive	CALL

PILLOW SPEAKER TESTER

DESCRIPTION	MODEL #	PART #	PRICE
Tester with one module	CT-300	6333	\$395.95
Additional module for this nurse call system	CALL	CALL	\$86.95

PILLOW SPEAKER REPLACEMENT CABLES

DESCRIPTION	LENGTH	MODEL #	PART #	PRICE
Replacement cable for Gen4 and Gen4+ pillow speakers	8'	CAD-3000	CALL	\$40.95

CALL CORDS (1/4" accessories may require an adaptor)

DESCRIPTION	LENGTH	15-PIN MODEL #	PART #	PRICE	1/4" PLUG MODEL #	PART #	PRICE
Gen4 Sealed Call Cord	8'	—	—	—	SCC-0101-080-N	13259	\$17.20
Gen4 Sealed Call Cord	12'	—	—	—	SCC-0101-120-N	13261	\$19.20
Classic Call Cord	8'	CC96-985	5875	\$36.95	CC96-010	5822	\$14.95
Classic Call Cord	12'	—	—	—	CC144-010	5733	\$16.95
BreathCall	9'	GEB-070	7384	\$185.96	GEB-010	7380	\$143.12
E-Z Call	10'	—	—	—	GEE-010	7402	\$69.95
Mechanical Pad	10'	GEM-070	7416	\$52.95	GEM-0000-AGY	7407	\$43.95
PadCall	8'	GEA-100	7356	\$94.00	GEA-030	7351	\$53.25
PressCall	8'	GEP-200	7444	\$81.46	GEP-140	7441	\$41.75

DUMMY PLUGS

DESCRIPTION	MODEL #	PART #	PRICE
1/4" plug, metal plug, overmolded, 6" poly cord	DP-020	6834	\$5.25
15-Pin, 6" Poly cord	DP-040	6836	\$12.95

REPLACEMENT PILLOW SPEAKERS AND ACCESSORIES FOR HCE/Sylvania® (All Systems)

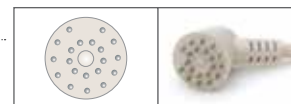

PILLOW SPEAKERS

TYPE	FEATURES	DIGITAL VOLUME MODEL #	PRICE	ANALOG VOLUME MODEL #	PRICE
Gen4+ DirectAccess	Nurse, TV, 0-9 Keypad	5C080-0-DV	\$102.95	5C080-0-AV	\$107.95
	Nurse, TV, 0-9 Keypad, 1 Light	5C080-1-DV	\$104.95	5C080-1-AV	\$109.95
	Nurse, TV, 0-9 Keypad, 2 Lights	5C080-2-DV	\$106.95	5C080-2-AV	\$111.95
Gen4 Digital	Nurse, TV	4D080-0-DV	\$92.95	4D080-0-AV	\$97.95
	Nurse, TV, 1 Light	4D080-1-DV	\$94.95	4D080-1-AV	\$99.95
	Nurse, TV, 2 Lights	4D080-2-DV	\$96.95	4D080-2-AV	\$101.95

NOTE: Call for complete pillow speaker part numbers.

Part numbers are based on standard wiring and 8 ft. cable length. Call for additional options including ear jack, alternate cable length, and auxiliaries.

PILLOW SPEAKER REPAIR

DESCRIPTION	PRICE
Repair of Gen4+ DirectAccess, Gen4 Digital, or Gen4 Interactive	CALL

PILLOW SPEAKER TESTER

DESCRIPTION	MODEL #	PART #	PRICE
Tester with one module	CT-300	6333	\$395.95
Additional module for this nurse call system	CALL	CALL	\$96.95

PILLOW SPEAKER REPLACEMENT CABLES

DESCRIPTION	LENGTH	MODEL #	PART #	PRICE
Replacement cable for Gen4 and Gen4+ pillow speakers	8'	CAD-0801	CALL	\$38.95

CALL CORDS

DESCRIPTION	LENGTH	20-PIN PLUG MODEL #	PART #	PRICE
Classic Call Cord	8'	CC96-160	5840	\$32.95
BreathCall	9'	GEB-110	7385	\$154.61
Mechanical Pad	10'	GEM-472	7431	\$48.95
PadCall	8'	GEA-110	14650	\$79.37
PressCall	8'	GEP-220	14270	\$64.74

ADAPTORS (see page 33 for descriptions of adaptor types)

TYPE	PLUG STYLE	RECEPTACLE 1	RECEPTACLE 2	RECEPTACLE 3	MODEL #	PART #	PRICE
Box	20-Pin	20-Pin	1/4" jack (nurse call)	1/4" jack (TV)	ADP-0320F-104	3263	\$96.95
Box	20-Pin	20-Pin	20-Pin	–	ADP-0320F-105	3264	\$100.95

REPLACEMENT PILLOW SPEAKERS AND ACCESSORIES FOR

Hillrom® COMposer®, and NaviCare®

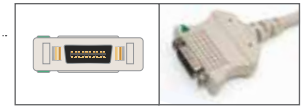

PILLOW SPEAKERS

TYPE	FEATURES	DIGITAL VOLUME MODEL #	PRICE	ANALOG VOLUME MODEL #	PRICE
Gen4+ DirectAccess	Nurse, TV, 0-9 Keypad	5C330-0-DV	\$107.95	5C330-0-AV	\$112.95
	Nurse, TV, 0-9 Keypad, 1 Light	5C330-1-DV	\$109.95	5C330-1-AV	\$114.95
	Nurse, TV, 0-9 Keypad, 2 Lights	5C330-2-DV	\$111.95	5C330-2-AV	\$116.95
	Nurse, TV, 0-9 Keypad, Microphone	5C331-0-DV	\$131.95	5C331-0-AV	\$136.95
	Nurse, TV, 0-9 Keypad, 1 Light, Microphone	5C331-1-DV	\$133.95	5C331-1-AV	\$138.95
	Nurse, TV, 0-9 Keypad, 2 Lights, Microphone	5C331-2-DV	\$135.95	5C331-2-AV	\$140.95
	Nurse, TV, 0-9 Keypad, Microphone, Pain/Toilet	5C331-PT-DV	\$141.95	5C331-PT-AV	\$146.95
	Nurse, TV, 0-9 Keypad, 1 Light, Microphone, Pain/Toilet	5C331-3-DV	\$143.95	5C331-3-AV	\$148.95
	Nurse, TV, 0-9 Keypad, 2 Lights, Microphone, Pain/Toilet	5C331-4-DV	\$145.95	5C331-4-AV	\$150.95
Gen4 Digital	Nurse, TV	4D330-0-DV	\$103.95	4D330-0-AV	\$108.95
	Nurse, TV, 1 Light	4D330-1-DV	\$105.95	4D330-1-AV	\$110.95
	Nurse, TV, 2 Lights	4D330-2-DV	\$107.95	4D330-2-AV	\$112.95
	Nurse, TV, Microphone	4D331-0-DV	\$126.95	4D331-0-AV	\$131.95
	Nurse, TV, 1 Light, Microphone	4D331-1-DV	\$128.95	4D331-1-AV	\$133.95
	Nurse, TV, 2 Lights, Microphone	4D331-2-DV	\$130.95	4D331-2-AV	\$135.95
	Nurse, TV, Microphone, Pain/Toilet	4D331-PT-DV	\$136.95	4D331-PT-AV	\$141.95
	Nurse, TV, 1 Light, Microphone, Pain/Toilet	4D331-3-DV	\$138.95	4D331-3-AV	\$143.95
	Nurse, TV, 2 Lights, Microphone, Pain/Toilet	4D331-4-DV	\$140.95	4D331-4-AV	\$145.95

NOTE: Call for complete pillow speaker part numbers.

Part numbers are based on standard wiring and 8 ft. cable length. Call for additional options including ear jack, alternate cable length, and auxiliaries.

PILLOW SPEAKER REPAIR

DESCRIPTION	PRICE
Repair of Gen4+ DirectAccess, Gen4 Digital, or Gen4 Interactive	CALL

PILLOW SPEAKER TESTER (May not test all functions of every model — call for details)

DESCRIPTION	MODEL #	PART #	PRICE
Tester with one module	CT-300	6333	\$395.95
Additional module for this nurse call system	CALL	CALL	\$129.95

PILLOW SPEAKER REPLACEMENT CABLES

DESCRIPTION	LENGTH	MODEL #	PART #	PRICE
Replacement cable for Gen4 and Gen4+ pillow speakers	8'	CAD-3300	CALL	\$46.95

PILLOW SPEAKER BREAKAWAY CABLES

DESCRIPTION	LENGTH	MODEL #	PART #	PRICE
20-pin breakaway cable with clamp	24"	JUP-5335-200	25000	\$59.95

CALL CORDS (1/4" accessories may require an adaptor)

DESCRIPTION	LENGTH	20-PIN MODEL #	PART #	PRICE	1/4" PLUG MODEL #	PART #	PRICE
Gen4 Sealed Call Cord	8'	—	—	—	SCC-0101-080-U	13260	\$17.20
Gen4 Sealed Call Cord	12'	—	—	—	SCC-0101-120-U	13262	\$19.20
Classic Call Cord	8'	CC96-892	5866	\$39.95	CC96-010	5822	\$14.95
Classic Call Cord	12'	—	—	—	CC144-010	5733	\$16.95
BreathCall	9'	—	—	—	GEB-010	7380	\$143.12
E-Z Call	10'	—	—	—	GEE-010	7402	\$69.95
Mechanical Pad	10'	GEM-035	7415	\$72.95	GEM-0000-AGY	7407	\$43.95
PadCall	8'	—	—	—	GEA-030	7351	\$53.25
PressCall	8'	—	—	—	GEP-140	7441	\$41.75

ADAPTORS (see page 33 for descriptions of adaptor types)

TYPE	PLUG STYLE	RECEPTACLE 1	RECEPTACLE 2	RECEPTACLE 3	MODEL #	PART #	PRICE
Box	20-Pin	20-Pin	1/4" jack (nurse)	—	ADP-2020-101	3367	\$140.95
Box	20-Pin	20-Pin	1/4" jack (nurse)	1/4" jack (TV)	ADP-2020-102	3368	\$150.95

DUMMY PLUGS

DESCRIPTION	MODEL #	PART #	PRICE
1/4" plug, metal plug, overmolded, 6" poly cord	DP-020	6834	\$5.25

REPLACEMENT PILLOW SPEAKERS AND ACCESSORIES FOR

Hillrom® DB37, Headwall



PILLOW SPEAKERS

TYPE	FEATURES	DIGITAL VOLUME MODEL #	PRICE	ANALOG VOLUME MODEL #	PRICE
Gen4+ DirectAccess	Nurse, TV, 0-9 Keypad	5C360-0-DV	\$103.95	5C360-0-AV	\$108.95
	Nurse, TV, 0-9 Keypad, 1 Light	5C360-1-DV	\$105.95	5C360-1-AV	\$110.95
	Nurse, TV, 0-9 Keypad, 2 Lights	5C360-2-DV	\$107.95	5C360-2-AV	\$112.95
Gen4 Digital	Nurse, TV	4D360-0-DV	\$97.95	4D360-0-AV	\$102.95
	Nurse, TV, 1 Light	4D360-1-DV	\$99.95	4D360-1-AV	\$104.95
	Nurse, TV, 2 Lights	4D360-2-DV	\$101.95	4D360-2-AV	\$106.95

NOTE: Call for complete pillow speaker part numbers.

Part numbers are based on standard wiring and 8 ft. cable length. Call for additional options including ear jack, alternate cable length, and auxiliaries.

PILLOW SPEAKER REPAIR

DESCRIPTION	PRICE
Repair of Gen4+ DirectAccess, Gen4 Digital, or Gen4 Interactive	CALL

PILLOW SPEAKER TESTER

DESCRIPTION	MODEL #	PART #	PRICE
Tester with one module	CT-300	6333	\$395.95
Additional module for this nurse call system	CALL	CALL	\$92.95

PILLOW SPEAKER REPLACEMENT CABLES

DESCRIPTION	LENGTH	MODEL #	PART #	PRICE
Replacement cable for Gen4 and Gen4+ pillow speakers	8'	CAD-3600	CALL	\$47.95

CALL CORDS (1/4" accessories may require an adaptor)

DESCRIPTION	LENGTH	37-PIN MODEL #	PART #	PRICE	1/4" PLUG MODEL #	PART #	PRICE
Gen4 Sealed Call Cord	8'	—	—	—	SCC-0101-080-N	13259	\$17.20
Gen4 Sealed Call Cord	12'	—	—	—	SCC-0101-120-N	13261	\$19.20
Classic Call Cord	8'	—	—	—	CC96-010	5822	\$14.95
Classic Call Cord	12'	—	—	—	CC144-010	5733	\$16.95
BreathCall	9'	—	—	—	GEB-010	7380	\$143.12
E-Z Call	10'	—	—	—	GEE-010	7402	\$69.95
Mechanical Pad	10'	GEM-150	7420	\$57.95	GEM-0000-AGY	7407	\$43.95
PadCall	8'	—	—	—	GEA-030	7351	\$53.25
PressCall	8'	—	—	—	GEP-140	7441	\$41.75

ADAPTORS (see page 33 for descriptions of adaptor types)

TYPE	PLUG STYLE	RECEPTACLE 1	RECEPTACLE 2	RECEPTACLE 3	MODEL #	PART #	PRICE
Box	37-Pin	37-Pin	1/4" jack (nurse call)	1/4" jack (TV)	ADP-3703-104	16661	\$114.95
Box	37-Pin	7-Pin	1/4" jack (nurse call)	—	ADP-3703-101	16659	\$103.95
Conversion	37-Pin	1/4" jack (bed exit)	—	—	AD-155	3237	\$21.95

DUMMY PLUGS

DESCRIPTION	MODEL #	PART #	PRICE
37-pin, 6" Poly Cord (Jump 7 and 25, 10 and 11)	DP-100	6846	\$12.55
37-pin, 6" Poly Cord (Jump 7 and 25, 8 and 9, 10 and 11)	DP-110	6849	\$13.60

REPLACEMENT PILLOW SPEAKERS AND ACCESSORIES FOR

INTERCALL® Legend II, Equinox II, Spectrum II, Ultra 6000, 6900, 9000



PILLOW SPEAKERS

TYPE	FEATURES	DIGITAL VOLUME MODEL #	PRICE	ANALOG VOLUME MODEL #	PRICE
Gen4+ DirectAccess	Nurse, TV, 0-9 Keypad	5C19D-0-DV	\$102.95	5C19D-0-AV	\$107.95
	Nurse, TV, 0-9 Keypad, 1 Light	5C19D-1-DV	\$104.95	5C19D-1-AV	\$109.95
	Nurse, TV, 0-9 Keypad, 2 Lights	5C19D-2-DV	\$106.95	5C19D-2-AV	\$111.95
Gen4 Digital	Nurse, TV	4D19D-0-DV	\$89.95	4D19D-0-AV	\$94.95
	Nurse, TV, 1 Light	4D19D-1-DV	\$91.95	4D19D-1-AV	\$96.95
	Nurse, TV, 2 Lights	4D19D-2-DV	\$93.95	4D19D-2-AV	\$98.95

NOTE: Call for complete pillow speaker part numbers.

Part numbers are based on standard wiring and 8 ft. cable length. Call for additional options including ear jack, alternate cable length, and auxiliaries.

PILLOW SPEAKER REPAIR

DESCRIPTION	PRICE
Repair of Gen4+ DirectAccess, Gen4 Digital, or Gen4 Interactive	CALL

PILLOW SPEAKER TESTER

DESCRIPTION	MODEL #	PART #	PRICE
Tester with one module	CT-300	6333	\$395.95
Additional module for this nurse call system	CALL	CALL	\$75.95

PILLOW SPEAKER REPLACEMENT CABLES

DESCRIPTION	LENGTH	MODEL #	PART #	PRICE
Replacement cable for Gen4 and Gen4+ pillow speakers	8'	CAD-19001	CALL	\$30.95

PILLOW SPEAKER BREAKAWAY CABLES

DESCRIPTION	LENGTH	MODEL #	PART #	PRICE
8-pin DIN breakaway cable with clamp	10"	JUP-1000-010-002	8482	\$18.95
8-pin DIN breakaway cable with clamp	10" with 60° plug	JUP-1003-010-002	8489	\$18.95
8-pin DIN breakaway cable with clamp	24"	JUP-1000-024-002	8483	\$19.95
8-pin DIN breakaway cable with clamp	30"	JUP-1000-030-002	8484	\$20.95
8-pin DIN extension cable with clamp	7'	JUP-1000-084-002	8485	\$24.95
8-pin DIN extension cable with clamp	12'	JUP-1000-144-002	8486	\$34.95

CALL CORDS (1/4" accessories may require an adaptor)

DESCRIPTION	LENGTH	8-PIN DIN MODEL #	PART #	PRICE	1/4" PLUG MODEL #	PART #	PRICE
Gen4 Sealed Call Cord	8'	—	—	—	SCC-0101-080-U	13260	\$17.20
Gen4 Sealed Call Cord	12'	—	—	—	SCC-0101-120-U	13262	\$19.20
Classic Call Cord	8'	CC96-200	5845	\$24.95	CC96-010	5822	\$14.95
Classic Call Cord	12'	—	—	—	CC144-010	5733	\$16.95
BreathCall	9'	GEB-157	7389	\$173.42	GEB-010	7380	\$143.12
E-Z Call	10'	—	—	—	GEE-010	7402	\$69.95
Mechanical Pad	10'	GEM-300	7425	\$47.95	GEM-0000-AGY	7407	\$43.95
PadCall	8'	GEA-138	7361	\$76.24	GEA-030	7351	\$53.25
PressCall	8'	GEP-565	7466	\$64.74	GEP-140	7441	\$41.75

ADAPTORS (see page 33 for descriptions of adaptor types)

TYPE	PLUG STYLE	RECEPTACLE 1	RECEPTACLE 2	RECEPTACLE 3	MODEL #	PART #	PRICE
Box	8-Pin DIN	8-Pin DIN	1/4" jack (nurse call)	—	ADP-0800-105	3286	\$79.95
Box	8-Pin DIN	8-Pin DIN	1/4" jack (nurse call)	1/4" jack (TV)	ADP-0800-107	3288	\$89.95

DUMMY PLUGS

DESCRIPTION	MODEL #	PART #	PRICE
8-Pin DIN, 6" cord	DPG-1900-001	6875	\$9.95
1/4" plug, metal plug, overmolded, 6" poly cord	DP-020	6834	\$5.25

REPLACEMENT PILLOW SPEAKERS AND ACCESSORIES FOR JERON® Pro-Alert™ 640, Provider® 680, Spectrum® Pro IR



PILLOW SPEAKERS

TYPE	FEATURES	DIGITAL VOLUME MODEL #	PRICE	ANALOG VOLUME MODEL #	PRICE
Gen4+ DirectAccess	Nurse, TV, 0-9 Keypad	5C19C-0-DV	\$102.95	5C19C-0-AV	\$107.95
	Nurse, TV, 0-9 Keypad, 1 Light	5C19C-1-DV	\$104.95	5C19C-1-AV	\$109.95
	Nurse, TV, 0-9 Keypad, 2 Lights	5C19C-2-DV	\$106.95	5C19C-2-AV	\$111.95
Gen4 Digital	Nurse, TV	4D19C-0-DV	\$89.95	4D19C-0-AV	\$94.95
	Nurse, TV, 1 Light	4D19C-1-DV	\$91.95	4D19C-1-AV	\$96.95
	Nurse, TV, 2 Lights	4D19C-2-DV	\$93.95	4D19C-2-AV	\$98.95

NOTE: Call for complete pillow speaker part numbers.

Part numbers are based on standard wiring and 8 ft. cable length. Call for additional options including ear jack, alternate cable length, and auxiliaries.

PILLOW SPEAKER REPAIR

DESCRIPTION	PRICE
Repair of Gen4+ DirectAccess, Gen4 Digital, or Gen4 Interactive	CALL

PILLOW SPEAKER TESTER

DESCRIPTION	MODEL #	PART #	PRICE
Tester with one module	CT-300	6333	\$395.95
Additional module for this nurse call system	CALL	CALL	\$75.95

PILLOW SPEAKER REPLACEMENT CABLES

DESCRIPTION	LENGTH	MODEL #	PART #	PRICE
Replacement cable for Gen4 and Gen4+ pillow speakers	8'	CAD-1900J	CALL	\$30.95

PILLOW SPEAKER BREAKAWAY AND EXTENSION CABLES

DESCRIPTION	LENGTH	MODEL #	PART #	PRICE
8-Pin DIN breakaway cable with clamp	10"	JUP-1000-010-002	8482	\$18.95
8-Pin DIN breakaway cable with clamp	10" with 60° plug	JUP-1003-010-002	8489	\$18.95
8-Pin DIN breakaway cable with clamp	24"	JUP-1000-024-002	8483	\$19.95
8-Pin DIN breakaway cable with clamp	30"	JUP-1000-030-002	8484	\$20.95
8-Pin DIN extension cable with clamp	7'	JUP-1000-084-002	8485	\$24.95
8-Pin DIN extension cable with clamp	12'	JUP-1000-144-002	8486	\$34.95

CALL CORDS (1/4" accessories may require an adaptor)

DESCRIPTION	LENGTH	8-PIN DIN MODEL #	PART #	PRICE	1/4" PLUG MODEL #	PART #	PRICE
Gen4 Sealed Call Cord	8'	SCC-1901-081-U	13268	\$27.20	SCC-0101-080-N	13259	\$17.20
Gen4 Sealed Call Cord	12'	—	—	—	SCC-0101-120-N	13261	\$19.20
Classic Call Cord	8'	CC96-300	5851	\$24.95	CC96-010	5822	\$14.95
Classic Call Cord	12'	CC144-466	5755	\$28.95	CC144-010	5733	\$16.95
BreathCall	9'	GEB-155	7388	\$173.42	GEB-010	7380	\$143.12
E-Z Call	10'	—	—	—	GEE-010	7402	\$69.95
Mechanical Pad	10'	GEM-180	7423	\$47.95	GEM-0000-AGY	7407	\$43.95
PadCall	8'	GEA-135	7359	\$76.24	GEA-030	7351	\$53.25
PressCall	8'	GEP-265	7450	\$64.74	GEP-140	7441	\$41.75

ADAPTORS (see page 33 for descriptions of adaptor types)

TYPE	PLUG STYLE	RECEPTACLE 1	RECEPTACLE 2	RECEPTACLE 3	MODEL #	PART #	PRICE
Box	8-Pin DIN	8-Pin DIN	1/4" jack (nurse call)	—	ADP-0800-101	3283	\$79.95
Conversion	8-Pin DIN	1/4" jack (nurse call)	—	—	AD-110	3233	\$29.95
Jumper	8-Pin DIN	8-Pin DIN	1/4" jack (nurse call)	—	JUP-1101-002	18194	\$52.95
Jumper	8-Pin DIN	1/4" jack (nurse call)	—	—	JUP-1055-101-002	8513	\$18.95

DUMMY PLUGS

DESCRIPTION	MODEL #	PART #	PRICE
1/4" plug, metal plug, overmolded, 6" poly cord	DP-020	6834	\$5.25
8-Pin DIN, no cord	DP-062	6840	\$8.95
8-Pin DIN, 6" Poly Cord	DP-066	6842	\$10.95

REPLACEMENT PILLOW SPEAKERS AND ACCESSORIES FOR

Jeron® 680+

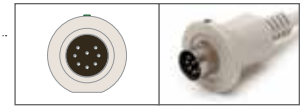

PILLOW SPEAKERS

TYPE	FEATURES	DIGITAL VOLUME MODEL #	PRICE	ANALOG VOLUME MODEL #	PRICE
Gen4+ DirectAccess	Nurse, TV, 0-9 Keypad	5C19J-0-DV	\$107.95	5C19J-0-AV	\$112.95
	Nurse, TV, 0-9 Keypad, 1 Light	5C19J-1-DV	\$109.95	5C19J-1-AV	\$114.95
	Nurse, TV, 0-9 Keypad, 2 Lights	5C19J-2-DV	\$111.95	5C19J-2-AV	\$116.95
Gen4 Digital	Nurse, TV	4D19J-0-DV	\$94.95	4D19J-0-AV	\$99.95
	Nurse, TV, 1 Light	4D19J-1-DV	\$96.95	4D19J-1-AV	\$101.95
	Nurse, TV, 2 Lights	4D19J-2-DV	\$98.95	4D19J-2-AV	\$103.95

NOTE: Call for complete pillow speaker part numbers.

Part numbers are based on standard wiring and 8 ft. cable length. Call for additional options including ear jack, alternate cable length, and auxiliaries.

PILLOW SPEAKER REPAIR

DESCRIPTION	PRICE
Repair of Gen4+ DirectAccess, Gen4 Digital, or Gen4 Interactive	CALL

PILLOW SPEAKER TESTER

DESCRIPTION	MODEL #	PART #	PRICE
Tester with one module	CT-300	6333	\$395.95
Additional module for this nurse call system	CALL	CALL	\$75.95

PILLOW SPEAKER REPLACEMENT CABLES

DESCRIPTION	LENGTH	MODEL #	PART #	PRICE
Replacement cable for Gen4 and Gen4+ pillow speakers	8'	CAD-4200	CALL	\$35.95

PILLOW SPEAKER BREAKAWAY CABLES

DESCRIPTION	LENGTH	MODEL #	PART #	PRICE
8-Pin DIN (bell shape) breakaway cable with clamp	10"	JUP-1008-010-002	8492	\$21.95

CALL CORDS (1/4" accessories may require an adaptor)

DESCRIPTION	LENGTH	8-PIN DIN MODEL #	PART #	PRICE	1/4" PLUG MODEL #	PART #	PRICE
Gen4 Sealed Call Cord	10'	SCC-4201-101-U	13286	\$30.20	SCC-0101-080-U	13260	\$17.20
Gen4 Sealed Call Cord	12'	-	-	-	SCC-0101-120-U	13262	\$19.20
Classic Call Cord	8'	CC96-300	5851	\$24.95	CC96-010	5822	\$14.95
Classic Call Cord	12'	CC144-466	5755	\$28.95	CC144-010	5733	\$16.95
BreathCall	9'	GEB-155	7388	\$173.42	GEB-010	7380	\$143.12
E-Z Call	10'	-	-	-	GEE-010	7402	\$69.95
Mechanical Pad	10'	GEM-180	7423	\$47.95	GEM-0000-AGY	7407	\$43.95
PadCall	8'	GEA-135	7359	\$76.24	GEA-030	7351	\$53.25
PressCall	8'	GEP-265	7450	\$64.74	GEP-140	7441	\$41.75

ADAPTORS (see page 33 for descriptions of adaptor types)

TYPE	PLUG STYLE	RECEPTACLE 1	RECEPTACLE 2	RECEPTACLE 3	MODEL #	PART #	PRICE
Box	8-Pin DIN (bell shape)	8-Pin DIN	1/4" jack (nurse call)	-	ADP-4200-101	3387	\$84.95

DUMMY PLUGS

DESCRIPTION	MODEL #	PART #	PRICE
8-Pin DIN, no cord	DP-062	6840	\$8.95
8-Pin DIN, 6" Poly Cord	DP-066	6842	\$10.95

REPLACEMENT PILLOW SPEAKERS AND ACCESSORIES FOR

Jeron® Provider 790



PILLOW SPEAKERS

TYPE	FEATURES	DIGITAL VOLUME MODEL #	PRICE	ANALOG VOLUME MODEL #	PRICE
Gen4+ DirectAccess	Nurse, TV, 0-9 Keypad, WT/PN/TL	5C421-0-DV	\$141.95	5C421-0-AV	\$146.95
	Nurse, TV, 0-9 Keypad, 1 Light, WT/PN/TL	5C421-1-DV	\$143.95	5C421-1-AV	\$148.95
	Nurse, TV, 0-9 Keypad, 2 Lights, WT/PN/TL	5C421-2-DV	\$145.95	5C421-2-AV	\$150.95
	Nurse, TV, 0-9 Keypad	5C420-0-DV	\$107.95	5C420-0-AV	\$112.95
	Nurse, TV, 0-9 Keypad, 1 Light	5C420-1-DV	\$109.95	5C420-1-AV	\$114.95
	Nurse, TV, 0-9 Keypad, 2 Lights	5C420-2-DV	\$111.95	5C420-2-AV	\$116.95
Gen4 Digital	Nurse, TV	4D420-0-DV	\$94.95	4D420-0-AV	\$99.95
	Nurse, TV, 1 Light	4D420-1-DV	\$96.95	4D420-1-AV	\$101.95
	Nurse, TV, 2 Lights	4D420-2-DV	\$98.95	4D420-2-AV	\$103.95

NOTE: Call for complete pillow speaker part numbers.

Part numbers are based on standard wiring and 8 ft. cable length. Call for additional options including ear jack, alternate cable length, and auxiliaries.

PILLOW SPEAKER REPAIR

DESCRIPTION	PRICE
Repair of Gen4+ DirectAccess, or Gen4 Interactive	CALL

PILLOW SPEAKER TESTER (May not test all functions of every model — call for details)

DESCRIPTION	MODEL #	PART #	PRICE
Tester with one module	CT-300	6333	\$395.95
Additional module for this nurse call system	CALL	CALL	CALL

PILLOW SPEAKER REPLACEMENT CABLES

DESCRIPTION	LENGTH	MODEL #	PART #	PRICE
Replacement cable for Gen4 and Gen4+ pillow speakers	8'	CAD-4200	CALL	\$35.95

PILLOW SPEAKER BREAKAWAY CABLES

DESCRIPTION	LENGTH	MODEL #	PART #	PRICE
8-pin DIN (bell shape) breakaway cable with clamp	10"	JUP-1008-010-002	8492	\$21.95

CALL CORDS (1/4" accessories may require an adaptor)

DESCRIPTION	LENGTH	8-PIN DIN MODEL #	PART #	PRICE	1/4" PLUG MODEL #	PART #	PRICE
Gen4 Sealed Call Cord	8'	SCC-1901-084-N	22129	\$30.20	SCC-0101-080-U	13260	\$17.20
Gen4 Sealed Call Cord	12'	—	—	—	SCC-0101-120-U	13262	\$19.20
Classic Call Cord	8'	—	—	—	CC96-010	5822	\$14.95
Classic Call Cord	12'	—	—	—	CC144-010	5733	\$16.95
BreathCall	9'	—	—	—	GEB-010	7380	\$143.12
E-Z Call	10'	—	—	—	GEE-010	7402	\$69.95
Mechanical Pad	10'	—	—	—	GEM-0000-AGY	7407	\$43.95
PadCall	8'	—	—	—	GEA-030	7351	\$53.25
PressCall	8'	—	—	—	GEP-140	7441	\$41.75

ADAPTORS (see page 33 for descriptions of adaptor types)

TYPE	PLUG STYLE	RECEPTACLE 1	RECEPTACLE 2	RECEPTACLE 3	MODEL #	PART #	PRICE
Box	8-Pin DIN	1/4" jack (nurse call)	—	—	JUP-1108-101	22034	\$34.95

DUMMY PLUGS

DESCRIPTION	MODEL #	PART #	PRICE
8-Pin DIN, no cord	DP-062	6840	\$8.95
8-Pin DIN, 6" Poly Cord	DP-066	6842	\$10.95

REPLACEMENT PILLOW SPEAKERS AND ACCESSORIES FOR

Rauland® Responder® III, 3000



PILLOW SPEAKERS

TYPE	FEATURES	DIGITAL VOLUME MODEL #	PRICE	ANALOG VOLUME MODEL #	PRICE
Gen4+ DirectAccess	Nurse, TV, 0-9 Keypad	5C100-0-DV	\$99.95	5C100-0-AV	\$104.95
	Nurse, TV, 0-9 Keypad, 1 Light	5C100-1-DV	\$101.95	5C100-1-AV	\$106.95
	Nurse, TV, 0-9 Keypad, 2 Lights	5C100-2-DV	\$103.95	5C100-2-AV	\$108.95
Gen4 Digital	Nurse, TV	4D100-0-DV	\$90.95	4D100-0-AV	\$95.95
	Nurse, TV, 1 Light	4D100-1-DV	\$92.95	4D100-1-AV	\$97.95
	Nurse, TV, 2 Lights	4D100-2-DV	\$94.95	4D100-2-AV	\$99.95

NOTE: Call for complete pillow speaker part numbers.

Part numbers are based on standard wiring and 8 ft. cable length. Call for additional options including ear jack, alternate cable length, and auxiliaries.

PILLOW SPEAKER REPAIR

DESCRIPTION	PRICE
Repair of Gen4+ DirectAccess, Gen4 Digital, or Gen4 Interactive	CALL

PILLOW SPEAKER TESTER

DESCRIPTION	MODEL #	PART #	PRICE
Tester with one module	CT-300	6333	\$395.95
Additional module for this nurse call system	CALL	CALL	\$84.95

PILLOW SPEAKER REPLACEMENT CABLES

DESCRIPTION	LENGTH	MODEL #	PART #	PRICE
Replacement cable for Gen4 and Gen4+ pillow speakers	8'	CAD-1000	CALL	\$34.95

CALL CORDS (1/4" accessories may require an adaptor)

DESCRIPTION	LENGTH	1/4" PLUG MODEL #	PART #	PRICE
Gen4 Sealed Call Cord	8'	SCC-0101-080-U	13260	\$17.20
Gen4 Sealed Call Cord	12'	SCC-0101-120-U	13262	\$19.20
Classic Call Cord	8'	CC96-010	5822	\$14.95
Classic Call Cord	12'	CC144-010	5733	\$16.95
BreathCall	9'	GEB-010	7380	\$143.12
E-Z Call	10'	GEE-010	7402	\$69.95
Mechanical Pad	10'	GEM-0000-AGY	7407	\$43.95
PadCall	8'	GEA-030	7351	\$53.25
PressCall	8'	GEP-140	7441	\$41.75

ADAPTORS (see page 33 for descriptions of adaptor types)

TYPE	PLUG STYLE	RECEPTACLE 1	RECEPTACLE 2	RECEPTACLE 3	MODEL #	PART #	PRICE
Box	12-Pin	12-Pin	1/4" jack (nurse call)	–	ADP-0412-101	3266	\$79.95
Box	12-Pin	12-Pin	1/4" jack (nurse call)	1/4" jack (TV)	ADP-0412-102	3267	\$89.95
Box	12-Pin	12-Pin	12-Pin	–	ADP-0412-103	3268	\$97.95

DUMMY PLUGS

DESCRIPTION	MODEL #	PART #	PRICE
1/4" plug, metal plug, overmolded, 6" poly cord	DP-020	6834	\$5.25
12-Pin, Jump 7 and 10	DP-200	6856	\$11.95

REPLACEMENT PILLOW SPEAKERS AND ACCESSORIES FOR Rauland® Responder® III+, IV, 4000, and 5000 systems



PILLOW SPEAKERS

TYPE	FEATURES	DIGITAL VOLUME MODEL #	PRICE	ANALOG VOLUME MODEL #	PRICE
Gen4+ DirectAccess	Nurse, TV, 0-9 Keypad	5C190-0-DV	\$102.95	5C190-0-AV	\$107.95
	Nurse, TV, 0-9 Keypad, 1 Light	5C190-1-DV	\$104.95	5C190-1-AV	\$109.95
	Nurse, TV, 0-9 Keypad, 2 Lights	5C190-2-DV	\$106.95	5C190-2-AV	\$111.95
Gen4 Digital	Nurse, TV	4D190-0-DV	\$89.95	4D190-0-AV	\$94.95
	Nurse, TV, 1 Light	4D190-1-DV	\$91.95	4D190-1-AV	\$96.95
	Nurse, TV, 2 Lights	4D190-2-DV	\$93.95	4D190-2-AV	\$98.95

NOTE: Call for complete pillow speaker part numbers.

Part numbers are based on standard wiring and 8 ft. cable length. Call for additional options including ear jack, alternate cable length, and auxiliaries.

PILLOW SPEAKER REPAIR

DESCRIPTION	PRICE
Repair of Gen4+ DirectAccess, Gen4 Digital, or Gen4 Interactive	CALL

PILLOW SPEAKER TESTER

DESCRIPTION	MODEL #	PART #	PRICE
Tester with one module	CT-300	6333	\$395.95
Additional module for this nurse call system	CALL	CALL	\$75.95

PILLOW SPEAKER REPLACEMENT CABLES

DESCRIPTION	LENGTH	MODEL #	PART #	PRICE
Replacement cable for Gen4 and Gen4+ pillow speakers	8'	CAD-1900R	CALL	\$30.95

PILLOW SPEAKER BREAKAWAY AND EXTENSIONS CABLES

DESCRIPTION	LENGTH	MODEL #	PART #	PRICE
8-Pin DIN breakaway cable with clamp	10"	JUP-1000-010-002	8482	\$18.95
8-Pin DIN breakaway cable with clamp	10" with 60° plug	JUP-1003-010-002	8489	\$18.95
8-Pin DIN breakaway cable with clamp	24"	JUP-1000-024-002	8483	\$19.95
8-Pin DIN breakaway cable with clamp	30"	JUP-1000-030-002	8484	\$20.95
8-Pin DIN extension cable with clamp	7'	JUP-1000-084-002	8485	\$24.95
8-Pin DIN extension cable with clamp	12'	JUP-1000-144-002	8486	\$34.95

CALL CORDS (1/4" accessories may require an adaptor)

DESCRIPTION	LENGTH	8-PIN DIN MODEL #	PART #	PRICE	1/4" PLUG MODEL #	PART #	PRICE
Gen4 Sealed Call Cord	8'	SCC-1901-080-U	13266	\$27.20	SCC-0101-080-U	13260	\$17.20
Gen4 Sealed Call Cord	12'	—	—	—	SCC-0101-120-U	13262	\$19.20
Classic Call Cord	8'	CC96-750	5860	\$24.95	CC96-010	5822	\$14.95
Classic Call Cord	12'	CC144-462	5754	\$27.95	CC144-010	5733	\$16.95
BreathCall	9'	GEB-150	7387	\$173.42	GEB-010	7380	\$143.12
E-Z Call	10'	—	—	—	GEE-010	7402	\$69.95
Mechanical Pad	10'	GEM-18	7422	\$47.95	GEM-0000-AGY	7407	\$43.95
PadCall	8'	GEA-130	7357	\$76.24	GEA-030	7351	\$53.25
PressCall	8'	GEP-260	7447	\$64.74	GEP-140	7441	\$41.75

ADAPTORS (see page 33 for descriptions of adaptor types)

SYSTEM	TYPE	PLUG STYLE	RECEPTACLE 1	RECEPTACLE 2	RECEPTACLE 3	MODEL #	PART #	PRICE
Responder III+, IV	Box	8-Pin DIN	8-Pin DIN	1/4" jack (nurse call)	NA	ADP-0800-113	3294	\$79.95
	Box	8-Pin DIN	8-Pin DIN	1/4" jack (nurse call)	1/4" (TV)	ADP-0800-117	3297	\$89.95
	Box	8-Pin DIN	8-Pin DIN	8-Pin DIN	NA	ADP-0800-118	3298	\$83.95
	Conversion	8-Pin DIN	1/4" jack (nurse call)	NA	NA	AD-120	3235	\$29.95
	Jumper	8-Pin DIN	8-Pin DIN	8-Pin DIN	NA	JUP-1100-001	18153	\$48.95
	Jumper	8-Pin DIN	8-Pin DIN	1/4" jack (nurse call)	NA	JUP-1101-001	18193	\$52.95
Responder 4000, 5000	Box	8-Pin DIN	8-Pin DIN	8-Pin DIN	NA	ADP-0800-110	3291	\$83.95
	Box	8-Pin DIN	8-Pin DIN	8-Pin DIN	1/4" jack (nurse call)	ADP-0800-115	3296	\$93.95
	Jumper	8-Pin DIN	8-Pin DIN	8-Pin DIN	NA	JUP-1100-002	18154	\$48.95
	Jumper	8-Pin DIN	8-Pin DIN	1/4" jack (nurse call)	NA	JUP-1101-001	18193	\$52.95

DUMMY PLUGS

DESCRIPTION	MODEL #	PART #	PRICE
8-Pin DIN, 6" cord	DP-140	6852	\$9.95
1/4" plug, metal plug, overmolded, 6" poly cord	DP-020	6834	\$5.25

REPLACEMENT PILLOW SPEAKERS AND ACCESSORIES FOR Rauland® Responder® 5/Enterprise Systems



PILLOW SPEAKERS

TYPE	FEATURES	DIGITAL VOLUME MODEL #	PRICE	ANALOG VOLUME MODEL #	PRICE
Gen4+ DirectAccess	Nurse, TV, 0-9 Keypad	5C410-0-DV	\$141.95	5C410-0-AV	\$146.95
	Nurse, TV, 0-9 Keypad, 1 Light	5C410-1-DV	\$143.95	5C410-1-AV	\$148.95
	Nurse, TV, 0-9 Keypad, 2 Lights	5C410-2-DV	\$145.95	5C410-2-AV	\$150.95
Gen4 Digital	Nurse, TV	4D410-0-DV	\$136.95	4D410-0-AV	\$141.95
	Nurse, TV, 1 Light	4D410-1-DV	\$138.95	4D410-1-AV	\$143.95
	Nurse, TV, 2 Lights	4D410-2-DV	\$140.95	4D410-2-AV	\$145.95

NOTE: Call for complete Pillow Speaker part numbers.

Part numbers are based on standard wiring and 10 ft. cable length. Call for additional options including ear jack, alternate cable length, and auxiliaries.

All Units ship standard with Water, Pain, and Toilet Nurse Call auxiliaries.

PILLOW SPEAKER REPAIR

DESCRIPTION	PRICE
Repair of Gen4+ DirectAccess, Gen4 Digital, or Gen4 Interactive	CALL

PILLOW SPEAKER TESTER

DESCRIPTION	MODEL #	PART #	PRICE
Responder 5 Pillow Speaker Tester	CT-5	14976	\$325.95

PILLOW SPEAKER REPLACEMENT CABLES

DESCRIPTION	LENGTH	MODEL #	PART #	PRICE
Replacement cable for Gen4 and Gen4+ pillow speakers	10'	CAD-9000	Call	\$36.95

PILLOW SPEAKER BREAKAWAY AND EXTENSION CABLES

DESCRIPTION	LENGTH	MODEL #	PART #	PRICE
9-pin DIN breakaway cable with clamp	24"	JUP-9000-2	8518	\$35.95
9-pin DIN extension cable with clamp	5'	JUP-9000-5	21741	\$38.95

CALL CORDS (1/4" accessories may require an adaptor)

DESCRIPTION	LENGTH	DIN MODEL #	PART #	PRICE	1/4" PLUG MODEL #	PART #	PRICE
Gen4 Sealed Call Cord	8'	SCC-1901-080-U	13266	\$27.20	SCC-0101-080-U	13262	\$17.20
Gen4 Sealed Call Cord	10'	SCC-4101-100-U	13285	\$34.20	-	-	-
Gen4 Sealed Call Cord	12'	-	-	-	SCC-0101-120-U	13262	\$19.20
BreathCall	9'	GEB-150	7387	\$173.42	GEB-010	7380	\$143.12
E-Z Call	10'	-	-	-	GEE-010	7402	\$69.95
Mechanical Pad	10'	GEM-18	7422	\$47.95	GEM-0000-AGY	7407	\$43.95
PadCall	8'	GEA-130	7357	\$76.24	GEA-030	7351	\$53.25
PressCall	8'	GEP-260	7447	\$64.74	GEP-140	7441	\$41.75

ASSISTIVE CONTROL ADAPTOR

TYPE	PLUG STYLE	RECEPTACLE 1	RECEPTACLE 2	RECEPTACLE 3	MODEL #	PART #	PRICE
Assistive Control Adaptor	9-Pin DIN	(2) 1/4"	(2) 1/8"	-	AC20	CALL	\$499.95

REPLACEMENT PILLOW SPEAKERS AND ACCESSORIES FOR

SimplexGrinnell® EZCare™



PILLOW SPEAKERS

TYPE	FEATURES	DIGITAL VOLUME MODEL #	PRICE	ANALOG VOLUME MODEL #	PRICE
Gen4+ DirectAccess	Nurse, TV, 0-9 Keypad	5C290-0-DV	\$126.95	5C290-0-AV	\$131.95
	Nurse, TV, 0-9 Keypad, 1 Light	5C290-1-DV	\$128.95	5C290-1-AV	\$133.95
	Nurse, TV, 0-9 Keypad, 2 Lights	5C290-2-DV	\$130.95	5C290-2-AV	\$135.95
	Nurse, TV, 0-9 Keypad	5C291-2-DVPSS-0	\$141.95	5C291-2-AVPSS-0	\$146.95
	Nurse, TV, 0-9 Keypad, 2 Lights	5C291-2-DVPSS-2	\$145.95	5C291-2-AVPSS-2	\$150.95
Gen4 Digital	Nurse, TV	4D290-0-DV	\$112.95	4D290-0-AV	\$117.95
	Nurse, TV, 1 Light	4D290-1-DV	\$114.95	4D290-1-AV	\$119.95
	Nurse, TV, 2 Lights	4D290-2-DV	\$116.95	4D290-2-AV	\$121.95
	Nurse, TV	4D291-2-DVPSS-0	\$136.95	4D291-2-AVPSS-0	\$141.95
	Nurse, TV, 2 Lights	4D291-2-DVPSS-2	\$140.95	4D291-2-AVPSS-2	\$145.95

NOTE: Call for complete pillow speaker part numbers.

Part numbers are based on standard wiring and 8 ft. cable length. Call for additional options including ear jack, alternate cable length, and auxiliaries.

PILLOW SPEAKER REPAIR

DESCRIPTION	PRICE
Repair of Gen4+ DirectAccess, Gen4 Digital, or Gen4 Interactive	CALL

PILLOW SPEAKER TESTER (May not test all functions of every model — call for details)

DESCRIPTION	MODEL #	PART #	PRICE
Tester with one module	CT-300	6333	\$395.95
Additional module for this nurse call system	CALL	CALL	\$86.95

PILLOW SPEAKER REPLACEMENT CABLES

DESCRIPTION	LENGTH	MODEL #	PART #	PRICE
Replacement cable for Gen4 and Gen4+ pillow speakers	8'	CAD-2900	CALL	\$49.95

CALL CORDS (1/4" accessories may require an adaptor)

DESCRIPTION	LENGTH	15-PIN MODEL #	PART #	PRICE	1/4" PLUG MODEL #	PART #	PRICE
Gen4 Sealed Call Cord	8'	SCC-2908	13277	\$47.20	SCC-0101-080-N	13259	\$17.20
Gen4 Sealed Call Cord	12'	—	—	—	SCC-0101-120-N	13261	\$19.20
Classic Call Cord	8'	CC96-983	5874	\$46.95	CC96-010	5822	\$14.95
Classic Call Cord	12'	—	—	—	CC144-010	5733	\$16.95
BreathCall	9'	GEB-375	7400	\$188.05	GEB-010	7380	\$143.12
E-Z Call	10'	—	—	—	GEE-010	7402	\$69.95
Mechanical Pad	10'	GEM-478	7434	\$52.95	GEM-0000-AGY	7407	\$43.95
PadCall	8'	GEA-360	7379	\$151.48	GEA-030	7351	\$53.25
PressCall	8'	GEP-670	7472	\$143.12	GEP-140	7441	\$41.75

ADAPTORS (see page 33 for descriptions of adaptor types)

TYPE	PLUG STYLE	RECEPTACLE 1	RECEPTACLE 2	RECEPTACLE 3	MODEL #	PART #	PRICE
Box	15-Pin	15-Pin	1/4" jack (nurse call)	1/4" jack (TV)	ADP-1500F-102	3350	\$170.95
Jumper	15-Pin	1/4" jack (nurse call)	—	—	JUP-1056-001-001	8515	\$39.95

DUMMY PLUGS

DESCRIPTION	MODEL #	PART #	PRICE
15-Pin, 6" Poly Cord	DP-095	6845	\$32.95

REPLACEMENT PILLOW SPEAKERS AND ACCESSORIES FOR TekTone® Tek-CARE® NC300 II, Tek-CARE 400

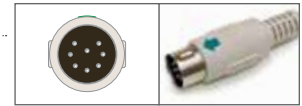

PILLOW SPEAKERS

TYPE	FEATURES	DIGITAL VOLUME MODEL #	PRICE	ANALOG VOLUME MODEL #	PRICE
Gen4+ DirectAccess	Nurse, TV, 0-9 Keypad	5C19E-0-DV	\$106.95	5C19E-0-AV	\$111.95
	Nurse, TV, 0-9 Keypad, 1 Light	5C19E-1-DV	\$108.95	5C19E-1-AV	\$113.95
	Nurse, TV, 0-9 Keypad, 2 Lights	5C19E-2-DV	\$110.95	5C19E-2-AV	\$115.95
Gen4 Digital	Nurse, TV	4D19E-0-DV	\$93.95	4D19E-0-AV	\$98.95
	Nurse, TV, 1 Light	4D19E-1-DV	\$95.95	4D19E-1-AV	\$100.95
	Nurse, TV, 2 Lights	4D19E-2-DV	\$97.95	4D19E-2-AV	\$102.95

NOTE: Call for complete pillow speaker part numbers.

Part numbers are based on standard wiring and 8 ft. cable length. Call for additional options including ear jack, alternate cable length, and auxiliaries.

PILLOW SPEAKER REPAIR

DESCRIPTION	PRICE
Repair of Gen4+ DirectAccess, Gen4 Digital, or Gen4 Interactive	CALL

PILLOW SPEAKER TESTER

DESCRIPTION	MODEL #	PART #	PRICE
Tester with one module	CT-300	6333	\$395.95
Additional module for this nurse call system	CALL	CALL	\$75.95

PILLOW SPEAKER REPLACEMENT CABLES

DESCRIPTION	LENGTH	MODEL #	PART #	PRICE
Replacement cable for Gen4 and Gen4+ pillow speakers	8'	CAD-1900T	CALL	\$30.95

PILLOW SPEAKER BREAKAWAY CABLES

DESCRIPTION	LENGTH	MODEL #	PART #	PRICE
8-pin DIN breakaway cable with clamp	10"	JUP-1000-010-002	8482	\$18.95
8-pin DIN breakaway cable with clamp	24"	JUP-1000-024-002	8483	\$19.95
8-pin DIN breakaway cable with clamp	30"	JUP-1000-030-002	8484	\$20.95
8-pin DIN extension cable with clamp	7'	JUP-1000-084-002	8485	\$24.95
8-pin DIN extension cable with clamp	12'	JUP-1000-144-002	8486	\$34.95

CALL CORDS (1/4" accessories may require an adaptor)

DESCRIPTION	LENGTH	8-PIN DIN MODEL #	PART #	PRICE	1/4" PLUG MODEL #	PART #	PRICE
Gen4 Sealed Call Cord	8'	SCC-1901-082-U	13269	\$27.20	SCC-0101-080-U	13260	\$17.20
Gen4 Sealed Call Cord	12'	-	-	-	SCC-0101-120-U	13262	\$19.20
Classic Call Cord	8'	CC96-970	5871	\$24.95	CC96-010	5822	\$14.95
Classic Call Cord	12'	-	-	-	CC144-010	5733	\$16.95
BreathCall	9'	-	-	-	GEB-010	7380	\$143.12
E-Z Call	10'	-	-	-	GEE-010	7402	\$69.95
Mechanical Pad	10'	GEM-476	7432	\$47.95	GEM-0000-AGY	7407	\$43.95
PadCall	8'	GEA-139	7362	\$76.24	GEA-030	7351	\$53.25
PressCall	8'	GEP-660	7471	\$64.74	GEP-140	7441	\$41.75

ADAPTORS (see page 33 for descriptions of adaptor types)

TYPE	PLUG STYLE	RECEPTACLE 1	RECEPTACLE 2	RECEPTACLE 3	MODEL #	PART #	PRICE
Box	8-Pin DIN	8-Pin DIN	1/4" jack (nurse call)		ADP-0800-109	3290	\$79.95
Box	8-Pin DIN	8-Pin DIN	1/4" jack (nurse call)	1/4" jack (TV)	ADP-0800-121	3300	\$89.95
Box	8-Pin DIN	8-Pin DIN	8-Pin DIN	1/4" jack (nurse call)	ADP-0800-108	3289	\$93.95

DUMMY PLUGS

DESCRIPTION	MODEL #	PART #	PRICE
8-Pin DIN, 6" cord	DP-141	6853	\$9.95

REPLACEMENT PILLOW SPEAKERS AND ACCESSORIES FOR

TekTone® Tek-CARE® NC3000 II



PILLOW SPEAKERS

TYPE	FEATURES	DIGITAL VOLUME MODEL #	PRICE	ANALOG VOLUME MODEL #	PRICE
Gen4+ DirectAccess	Nurse, TV, 0-9 Keypad	5C210-0-DV	\$94.95	5C210-0-AV	\$99.95
	Nurse, TV, 0-9 Keypad, 1 Light	5C210-1-DV	\$96.95	5C210-1-AV	\$101.95
	Nurse, TV, 0-9 Keypad, 2 Lights	5C210-2-DV	\$98.95	5C210-2-AV	\$103.95
Gen4 Digital	Nurse, TV	4D210-0-DV	\$89.95	4D210-0-AV	\$94.95
	Nurse, TV, 1 Light	4D210-1-DV	\$91.95	4D210-1-AV	\$96.95
	Nurse, TV, 2 Lights	4D210-2-DV	\$93.95	4D210-2-AV	\$98.95

NOTE: Call for complete pillow speaker part numbers.

Part numbers are based on standard wiring and 8 ft. cable length. Call for additional options including ear jack, alternate cable length, and auxiliaries.

PILLOW SPEAKER REPAIR

DESCRIPTION	PRICE
Repair of Gen4+ DirectAccess, Gen4 Digital, or Gen4 Interactive	CALL

PILLOW SPEAKER TESTER

DESCRIPTION	MODEL #	PART #	PRICE
Tester with one module	CT-300	6333	\$395.95
Additional module for this nurse call system	CALL	CALL	\$85.95

PILLOW SPEAKER REPLACEMENT CABLES

DESCRIPTION	LENGTH	MODEL #	PART #	PRICE
Replacement cable for Gen4 and Gen4+ pillow speakers	8'	CAD-2100T	CALL	\$28.95

CALL CORDS (1/4" accessories may require an adaptor)

DESCRIPTION	LENGTH	8-PIN MODULAR MODEL #	PART #	PRICE	1/4" PLUG MODEL #	PART #	PRICE
Gen4 Sealed Call Cord	8'	SCC-2101-080-N	13272	\$22.20	SCC-0101-080-U	13260	\$17.20
Gen4 Sealed Call Cord	12'	—	—	—	SCC-0101-120-U	13262	\$19.20
Classic Call Cord	8'	CC96-080	5835	\$19.95	CC96-010	5822	\$14.95
Classic Call Cord	12'	—	—	—	CC144-010	5733	\$16.95
BreathCall	9'	GEB-170	7391	\$173.42	GEB-010	7380	\$143.12
E-Z Call	10'	—	—	—	GEE-010	7402	\$69.95
Mechanical Pad	10'	GEM-471	7430	\$47.95	GEM-0000-AGY	7407	\$43.95
PadCall	8'	GEA-145	7364	\$76.24	GEA-030	7351	\$53.25
PressCall	8'	GEP-310	7453	\$64.74	GEP-140	7441	\$41.75

ADAPTORS (see page 33 for descriptions of adaptor types)

TYPE	PLUG STYLE	RECEPTACLE 1	RECEPTACLE 2	RECEPTACLE 3	MODEL #	PART #	PRICE
Box	8-Pin Modular	8-Pin Modular	1/4" jack (nurse call)	—	ADP-0808-101	3322	\$77.95
Box	8-Pin Modular	8-Pin Modular	1/4" jack (nurse call)	1/4" jack (TV)	ADP-0808-102	3323	\$87.95
Box	8-Pin Modular	8-Pin Modular	8-Pin Modular	—	ADP-0808-103	3324	\$91.95
Conversion	8-Pin Modular	1/4" jack (nurse call)	—	—	AD-030	3212	\$30.95

DUMMY PLUGS

DESCRIPTION	MODEL #	PART #	PRICE
8-Pin Modular, 6" Poly Cord	DP-082	6844	\$8.95

REPLACEMENT PILLOW SPEAKERS AND ACCESSORIES FOR West-Com West-Call® 1000, 8000, Endeavor, Marc II



PILLOW SPEAKERS

TYPE	FEATURES	DIGITAL VOLUME MODEL #	PRICE	ANALOG VOLUME MODEL #	PRICE
Gen4+ DirectAccess	Nurse, TV, 0-9 Keypad	5C215-0-DV	\$92.95	5C215-0-AV	\$97.95
	Nurse, TV, 0-9 Keypad, 1 Light	5C215-1-DV	\$94.95	5C215-1-AV	\$99.95
	Nurse, TV, 0-9 Keypad, 2 Lights	5C215-2-DV	\$96.95	5C215-2-AV	\$101.95
Gen4 Digital	Nurse, TV	4D215-0-DV	\$86.95	4D215-0-AV	\$91.95
	Nurse, TV, 1 Light	4D215-1-DV	\$88.95	4D215-1-AV	\$93.95
	Nurse, TV, 2 Lights	4D215-2-DV	\$90.95	4D215-2-AV	\$95.95

NOTE: Call for complete pillow speaker part numbers.

Part numbers are based on standard wiring and 8 ft. cable length. Call for additional options including ear jack, alternate cable length, and auxiliaries.

PILLOW SPEAKER REPAIR

DESCRIPTION	PRICE
Repair of Gen4+ DirectAccess, Gen4 Digital, or Gen4 Interactive	CALL

PILLOW SPEAKER TESTER

DESCRIPTION	MODEL #	PART #	PRICE
Tester with one module	CT-300	6333	\$395.95
Additional module for this nurse call system	CALL	CALL	\$85.95

PILLOW SPEAKER REPLACEMENT CABLES

DESCRIPTION	LENGTH	MODEL #	PART #	PRICE
Replacement cable for Gen4 and Gen4+ pillow speakers	8'	CAD-2100WC	CALL	\$28.95

PILLOW SPEAKER BREAKAWAY AND EXTENSION CABLES

DESCRIPTION	LENGTH	MODEL #	PART #	PRICE
8-pin Modular breakaway cable	6"	JU06-311	8124	\$18.95
8-pin Modular extension cable with clamp	6"	JU72-580	8426	\$23.95

CALL CORDS (1/4" accessories may require an adaptor)

DESCRIPTION	LENGTH	8-PIN MODULAR MODEL #	PART #	PRICE	1/4" PLUG MODEL #	PART #	PRICE
Gen4 Sealed Call Cord	8'	SCC-2101-080-N	13272	\$22.20	SCC-0101-080-N	13259	\$17.20
Gen4 Sealed Call Cord	12'	—	—	—	SCC-0101-120-N	13261	\$19.20
Classic Call Cord	8'	CC96-080	5835	\$19.95	CC96-010	5822	\$14.95
Classic Call Cord	12'	—	—	—	CC144-010	5733	\$16.95
BreathCall	9'	GEB-170	7391	\$173.42	GEB-010	7380	\$143.12
E-Z Call	10'	—	—	—	GEE-010	7402	\$69.95
Mechanical Pad	10'	GEM-471	7430	\$47.95	GEM-0000-AGY	7407	\$43.95
PadCall	8'	GEA-145	7364	\$76.24	GEA-030	7351	\$53.25
PressCall	8'	GEP-310	7453	\$64.74	GEP-140	7441	\$41.75

ADAPTORS (see page 33 for descriptions of adaptor types)

TYPE	PLUG STYLE	RECEPTACLE 1	RECEPTACLE 2	RECEPTACLE 3	MODEL #	PART #	PRICE
Box	8-Pin Modular	8-Pin Modular	1/4" jack (nurse call)	—	ADP-0808-101	3322	\$77.95
Box	8-Pin Modular	8-Pin Modular	1/4" jack (nurse call)	1/4" jack (TV)	ADP-0808-102	3323	\$87.95
Box	8-Pin Modular	8-Pin Modular	8-Pin Modular	—	ADP-0808-103	3324	\$91.95
Conversion	8-Pin Modular	1/4" jack (nurse call)	—	—	AD-030	3212	\$30.95

DUMMY PLUGS

DESCRIPTION	MODEL #	PART #	PRICE
1/4" plug, metal plug, overmolded, 6" poly cord	DP-020	6834	\$5.25
8-Pin Modular, 6" Poly Cord	DP-082	6844	\$8.95

REPLACEMENT PILLOW SPEAKERS AND ACCESSORIES FOR

West-Com Odyssey, Odyssey Plus, Novus®



PILLOW SPEAKERS

TYPE	FEATURES	DIGITAL VOLUME MODEL #	PRICE	ANALOG VOLUME MODEL #	PRICE
Gen4+ DirectAccess	Nurse, TV, 0-9 Keypad	5C240-0-DV	\$99.95	5C240-0-AV	\$104.95
	Nurse, TV, 0-9 Keypad, Light	5C240-1-DV	\$101.95	5C240-1-AV	\$106.95
	Nurse, TV, 0-9 Keypad, 2 Lights	5C240-2-DV	\$103.95	5C240-2-AV	\$108.95
	Nurse, TV, 0-9 Keypad, 2 Lights, Pain, Bed Pan	5C240-4-DV	\$107.95	5C240-4-AV	\$112.95
Gen4 Digital	Nurse, TV	4D240-0-DV	\$89.95	4D240-0-AV	\$94.95
	Nurse, TV, Light	4D240-1-DV	\$91.95	4D240-1-AV	\$96.95
	Nurse, TV, 2 Lights	4D240-2-DV	\$93.95	4D240-2-AV	\$98.95
	Nurse, TV, 2 Lights, Pain Med, Bed Pan	4D240-4-DV	\$97.95	4D240-4-AV	\$102.95

NOTE: Call for complete pillow speaker part numbers.

Part numbers are based on standard wiring and 8 ft. cable length. Call for additional options including ear jack, alternate cable length, and auxiliaries.

PILLOW SPEAKER REPAIR

DESCRIPTION	PRICE
Repair of Gen4+ DirectAccess, Gen4 Digital, or Gen4 Interactive	CALL

PILLOW SPEAKER TESTER

DESCRIPTION	MODEL #	PART #	PRICE
Tester with one module	CT-300	6333	\$395.95
Additional module for this nurse call system	CALL	CALL	\$87.95

PILLOW SPEAKER REPLACEMENT CABLES

DESCRIPTION	LENGTH	MODEL #	PART #	PRICE
Replacement cable for Gen4 and Gen4+ pillow speakers	8'	CAD-2400	CALL	\$28.95

PILLOW SPEAKER BREAKAWAY AND EXTENSION CABLES

DESCRIPTION	LENGTH	MODEL #	PART #	PRICE
10-Pin Modular breakaway cable	6"	JU06-311	8124	\$18.95
10-Pin Modular breakaway cable with clamp	12"	JU12-200	8167	\$19.95
10-Pin Modular extension cable with clamp	6'	JU72-580	8426	\$23.95

CALL CORDS (1/4" accessories may require an adaptor)

DESCRIPTION	LENGTH	10-PIN MODULAR MODEL #	PART #	PRICE	1/4" PLUG MODEL #	PART #	PRICE
Gen4 Sealed Call Cord	8'	SCC-2402-080-U	13276	\$25.20	SCC-0101-080-U	13260	\$17.20
Gen4 Sealed Call Cord	12'	-	-	-	SCC-0101-120-U	13262	\$19.20
Classic Call Cord	8'	CC96-661	5857	\$22.95	CC96-010	5822	\$14.95
Classic Call Cord	12'	-	-	-	CC144-010	5733	\$16.95
BreathCall	9'	GEB-175	7392	\$183.87	GEB-010	7380	\$143.12
E-Z Call	10'	-	-	-	GEE-010	7402	\$69.95
Mechanical Pad	10'	GEM-480	15014	\$47.95	GEM-0000-AGY	7407	\$43.95
PadCall	8'	GEA-146	7365	\$87.73	GEA-030	7351	\$53.25
PressCall	8'	GEP-610	7468	\$66.83	GEP-140	7441	\$41.75

ADAPTORS (see page 33 for descriptions of adaptor types)

TYPE	PLUG STYLE	RECEPTACLE 1	RECEPTACLE 2	RECEPTACLE 3	MODEL #	PART #	PRICE
Box	10-pin Modular	10-pin Modular	1/4" jack (nurse call)	-	ADP-1010-102	3341	\$82.95
Box	10-pin Modular	10-pin Modular	1/4" jack (nurse call)	1/4" jack (TV)	ADP-1010-103	3342	\$92.95
Box	10-pin Modular	10-pin Modular	8-pin Modular	-	ADP-1010-104	3343	\$96.95

DUMMY PLUGS

DESCRIPTION	MODEL #	PART #	PRICE
1/4" plug, metal plug, overmolded, 6" poly cord	DP-020	6834	\$5.25
10-Pin Modular, 6" Poly Cord	DP-255	6862	\$8.95

REPLACEMENT PILLOW SPEAKERS AND ACCESSORIES FOR

West-Com Odyssey, Odyssey Plus, Novus®



PILLOW SPEAKERS

TYPE	FEATURES	DIGITAL VOLUME MODEL #	PRICE	ANALOG VOLUME MODEL #	PRICE
Gen4+ DirectAccess	Nurse, TV, 0-9 Keypad	5C380-0-DV	\$121.95	5C380-0-AV	\$126.95
	Nurse, TV, 0-9 Keypad, 1 Light	5C380-1-DV	\$123.95	5C380-1-A	\$128.95
	Nurse, TV, 0-9 Keypad, 2 Lights	5C380-2-DV	\$125.95	5C380-2-AV	\$130.95
	Nurse, TV, 0-9 Keypad, 2 Lights, Pain, Bed Pan	5C380-4-DV	\$129.95	5C380-4-AV	\$134.95
Gen4 Digital	Nurse, TV	4D380-0-DV	\$107.95	4D380-0-AV	\$112.95
	Nurse, TV, 1 Light	4D380-1-DV	\$109.95	4D380-1-AV	\$114.95
	Nurse, TV, 2 Lights	4D380-2-DV	\$111.95	4D380-2-AV	\$116.95
	Nurse, TV, 2 Lights, Pain Med, Bed Pan	4D380-4-DV	\$115.95	4D380-4-AV	\$120.95

NOTE: Call for complete pillow speaker part numbers.

Part numbers are based on standard wiring and 8 ft. cable length. Call for additional options including ear jack, alternate cable length, and auxiliaries.

PILLOW SPEAKER REPAIR

DESCRIPTION	PRICE
Repair of Gen4+ DirectAccess, Gen4 Digital, or Gen4 Interactive	CALL

PILLOW SPEAKER TESTER

DESCRIPTION	MODEL #	PART #	PRICE
Tester with one module	CT-300	6333	\$395.95
Additional module for this nurse call system	CALL	CALL	\$87.95

PILLOW SPEAKER REPLACEMENT CABLES

DESCRIPTION	LENGTH	MODEL #	PART #	PRICE
Replacement cable for Gen4 and Gen4+ pillow speakers	8'	CAD-3800	CALL	\$42.95

PILLOW SPEAKER BREAKAWAY CABLES

DESCRIPTION	LENGTH	MODEL #	PART #	PRICE
10-pin Modular (male) to 12-pin (female) breakaway cable with clamp	12'	JUP-1002-001	8488	\$25.95

REPLACEMENT PILLOW SPEAKERS AND ACCESSORIES FOR

Zettler®/SimplexGrinnell® Sentinel 400™

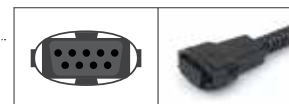

PILLOW SPEAKERS

TYPE	FEATURES	DIGITAL VOLUME MODEL #	PRICE	ANALOG VOLUME MODEL #	PRICE
Gen4+ DirectAccess	Nurse, TV, 0-9 Keypad	5C230-0-DV	\$102.95	5C230-0-AV	\$107.95
	Nurse, TV, 0-9 Keypad, 1 Light	5C230-1-DV	\$104.95	5C230-1-AV	\$109.95
	Nurse, TV, 0-9 Keypad, 2 Lights	5C230-2-DV	\$106.95	5C230-2-AV	\$111.95
Gen4 Digital	Nurse, TV	4D230-0-DV	\$93.95	4D230-0-AV	\$98.95
	Nurse, TV, 1 Light	4D230-1-DV	\$95.95	4D230-1-AV	\$100.95
	Nurse, TV, 2 Lights	4D230-2-DV	\$97.95	4D230-2-AV	\$102.95

NOTE: Call for complete pillow speaker part numbers.

Part numbers are based on standard wiring and 8 ft. cable length. Call for additional options including ear jack, alternate cable length, and auxiliaries.

PILLOW SPEAKER REPAIR

DESCRIPTION	PRICE
Repair of Gen4+ DirectAccess, Gen4 Digital, or Gen4 Interactive	CALL

PILLOW SPEAKER TESTER

DESCRIPTION	MODEL #	PART #	PRICE
Tester with one module	CT-300	6333	\$395.95
Additional module for this nurse call system	CALL	CALL	\$73.95

PILLOW SPEAKER REPLACEMENT CABLES

DESCRIPTION	LENGTH	MODEL #	PART #	PRICE
Replacement cable for Gen4 and Gen4+ pillow speakers	8'	CAD-2300	CALL	\$38.95

CALL CORDS (1/4" accessories may require an adaptor)

DESCRIPTION	LENGTH	9-PIN D-SUB MODEL # (NORMALLY OPEN)	PART #	PRICE	1/4" PLUG MODEL #	PART #	PRICE
Gen4 Sealed Call Cord	8'	—	—	—	SCC-0101-080-N	13259	\$17.20
Gen4 Sealed Call Cord	12'	—	—	—	SCC-0101-120-N	13261	\$19.20
Classic Call Cord	8'	CC96-347	5854	\$30.95	CC96-010	5822	\$14.95
Classic Call Cord	12'	—	—	—	CC144-010	5733	\$16.95
BreathCall	9'	GEB-190	7393	\$177.60	GEB-010	7380	\$143.12
E-Z Call	10'	—	—	—	GEE-010	7402	\$69.95
Mechanical Pad	10'	GEM-160	7421	\$59.95	GEM-0000-AGY	7407	\$43.95
PadCall	8'	GEA-180	7368	\$74.15	GEA-030	7351	\$53.25
PressCall	10'	GEP-540	19436	\$76.15	GEP-140	7441	\$41.75

ADAPTORS (see page 33 for descriptions of adaptor types)

TYPE	PLUG STYLE	RECEPTACLE 1	RECEPTACLE 2	RECEPTACLE 3	MODEL #	PART #	PRICE
Box	9-pin D-Sub	9-pin D-Sub	1/4" jack (nurse call)	—	ADP-0909-102	3328	\$88.95
Box	9-pin D-Sub	9-pin D-Sub	1/4" jack (nurse call)	1/4" jack (TV)	ADP-0909-108	3333	\$98.95

DUMMY PLUGS

DESCRIPTION	MODEL #	PART #	PRICE
9-Pin, 6" Poly Cord	DP-160	6854	\$10.95

REPLACEMENT PILLOW SPEAKERS AND ACCESSORIES FOR

Zettler®/SimplexGrinnell® Sentinel 500™

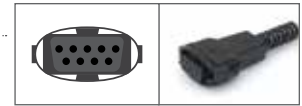

PILLOW SPEAKERS

TYPE	FEATURES	DIGITAL VOLUME MODEL #	PRICE	ANALOG VOLUME MODEL #	PRICE
Gen4+ DirectAccess	Nurse, TV, 0-9 Keypad	5C235-0-DV	\$102.95	5C235-0-AV	\$107.95
	Nurse, TV, 0-9 Keypad, 1 Light	5C235-1-DV	\$104.95	5C235-1-AV	\$109.95
	Nurse, TV, 0-9 Keypad, 2 Lights	5C235-2-DV	\$106.95	5C235-2-AV	\$111.95
Gen4 Digital	Nurse, TV	4D235-0-DV	\$93.95	4D235-0-AV	\$98.95
	Nurse, TV, 1 Light	4D235-1-DV	\$95.95	4D235-2-AV	\$100.95
	Nurse, TV, 2 Lights	4D235-2-DV	\$97.95	4D235-2-AV	\$102.95

NOTE: Call for complete pillow speaker part numbers.

Part numbers are based on standard wiring and 8 ft. cable length. Call for additional options including ear jack, alternate cable length, and auxiliaries.

PILLOW SPEAKER REPAIR

DESCRIPTION	PRICE
Repair of Gen4+ DirectAccess, Gen4 Digital, or Gen4 Interactive	CALL

PILLOW SPEAKER TESTER

DESCRIPTION	MODEL #	PART #	PRICE
Tester with one module	CT-300	6333	\$395.95
Additional module for this nurse call system	CALL	CALL	\$73.95

PILLOW SPEAKER REPLACEMENT CABLES

DESCRIPTION	LENGTH	MODEL #	PART #	PRICE
Replacement cable for Gen4 and Gen4+ pillow speakers	8'	CAD-2300	CALL	\$38.95

CALL CORDS (1/4" accessories may require an adaptor)

DESCRIPTION	LENGTH	9-PIN D-SUB MODEL # (NORMALLY CLOSED)	PART #	PRICE	1/4" PLUG MODEL # (NORMALLY CLOSED)	PART #	PRICE
Classic Call Cord	8'	CC96-740	5859	\$30.95	CC96-024 (black button)	5825	\$18.95
BreathCall	9'	GEB-195	7394	\$184.95	GEB-025	7382	\$143.12
E-Z Call	10'	—	—	—	GEE-090	7403	\$64.95
PadCall	8'	GEA-195	7371	\$92.96	GEA-080	7355	\$54.29
PressCall	8'	GEP-500	7462	\$79.37	GEP-045	7436	\$49.07

ADAPTORS (see page 33 for descriptions of adaptor types)

TYPE	PLUG STYLE	RECEPTACLE 1	RECEPTACLE 2	RECEPTACLE 3	MODEL #	PART #	PRICE
Box	9-Pin D-Sub	9-Pin D-Sub	1/4" jack (nurse call)	—	ADP-0909-103	3329	\$88.95
Box	9-Pin D-Sub	9-Pin D-Sub	1/4" jack (nurse call)	1/4" jack (TV)	ADP-0909-105	3330	\$98.95

DUMMY PLUGS

DESCRIPTION	MODEL #	PART #	PRICE
9-Pin, 6" Poly Cord	DP-165	6855	\$10.95

REPLACEMENT PILLOW SPEAKERS AND ACCESSORIES FOR Zenith (TV Control Only)



PILLOW SPEAKERS

TYPE	FEATURES	DIGITAL VOLUME MODEL #	PRICE	ANALOG VOLUME MODEL #	PRICE
Gen4+ DirectAccess	TV, 0-9 Keypad	5C020-0-DV	\$93.95	5C020-0-AV	\$98.95
	TV, 0-9 Keypad, 1 Light	5C020-1-DV	\$95.95	5C020-1-AV	\$100.95
Gen4 Digital	TV"	4D020-0-DV	\$77.95	4D020-0-AV	\$82.95
	TV, 1 Light	4D020-1-DV	\$79.95	4D020-1-AV	\$84.95

NOTE: Call for complete pillow speaker part numbers.

Part numbers are based on standard wiring and 8 ft. cable length. Call for additional options including ear jack, alternate cable length, and auxiliaries.

PILLOW SPEAKER REPAIR

DESCRIPTION	PRICE
Repair of Gen4+ DirectAccess, Gen4 Digital, or Gen4 Interactive	CALL

PILLOW SPEAKER TESTER

DESCRIPTION	MODEL #	PART #	PRICE
Tester with one module	CT-300	6333	\$395.95
Additional module for this nurse call system	CALL	CALL	\$79.95

PILLOW SPEAKER REPLACEMENT CABLES

DESCRIPTION	LENGTH	MODEL #	PART #	PRICE
Replacement cable for Gen4 and Gen4+ pillow speakers	8'	CAD-0200	CALL	\$23.95

REPLACEMENT PILLOW SPEAKERS AND ACCESSORIES FOR Applications Without Nurse Call



PILLOW SPEAKERS

TYPE	FEATURES	DIGITAL VOLUME MODEL #	PRICE	ANALOG VOLUME MODEL #	PRICE
Gen4+ DirectAccess	TV, 0-9 Keypad	5C010-0-DV	\$89.95	5C010-0-AV	\$94.95
Gen4 Digital	TV	4D010-0-DV	\$74.95	4D010-0-AV	\$79.95

NOTE: Call for complete pillow speaker part numbers.

Part numbers are based on standard wiring and 8 ft. cable length. Call for additional options including ear jack, alternate cable length, and auxiliaries.

PILLOW SPEAKER REPAIR

DESCRIPTION	PRICE
Repair of Gen4+ DirectAccess, Gen4 Digital, or Gen4 Interactive	CALL

PILLOW SPEAKER TESTER

DESCRIPTION	MODEL #	PART #	PRICE
Tester with one module	CT-300	6333	\$395.95
Additional module for this nurse call system	CALL	CALL	\$73.95

PILLOW SPEAKER REPLACEMENT CABLES

DESCRIPTION	LENGTH	MODEL #	PART #	PRICE
Replacement cable for Gen4 and Gen4+ pillow speakers	8'	CAD-0100	CALL	\$19.95

REPLACEMENT PILLOW SPEAKERS AND ACCESSORIES FOR Universal Centronics Breakaway Applications



PILLOW SPEAKERS

TYPE	FEATURES	DIGITAL VOLUME MODEL #	PRICE	ANALOG VOLUME MODEL #	PRICE
Gen4+ DirectAccess	Nurse, TV, 0-9 Keypad	5C350-0-DV	\$103.95	5C350-0-AV	\$108.95
	Nurse, TV, 0-9 Keypad, 1 Light	5C350-1-DV	\$105.95	5C350-1-AV	\$110.95
	Nurse, TV, 0-9 Keypad, 2 Lights	5C350-2-DV	\$107.95	5C350-2-AV	\$112.95
Gen4 Digital	Nurse, TV	4D350-0-DV	\$97.95	4D350-0-AV	\$102.95
	Nurse, TV, 1 Light	4D350-1-DV	\$99.95	4D350-1-AV	\$104.95
	Nurse, TV, 2 Lights	4D350-2-DV	\$101.95	4D350-2-AV	\$106.95

NOTE: Call for complete pillow speaker part numbers.

Part numbers are based on standard wiring and 8 ft. cable length. Call for additional options including ear jack, alternate cable length, and auxiliaries.

PILLOW SPEAKER REPAIR

DESCRIPTION	PRICE
Repair of Gen4+ DirectAccess, Gen4 Digital, or Gen4 Interactive	CALL

PILLOW SPEAKER TESTER

DESCRIPTION	MODEL #	PART #	PRICE
Tester with one module	CT-300	6333	\$395.95
Additional module for this nurse call system	CALL	CALL	\$95.95

PILLOW SPEAKER REPLACEMENT CABLES

DESCRIPTION	LENGTH	MODEL #	PART #	PRICE
Replacement cable for Gen4 and Gen4+ pillow speakers	8'	CAD-3500	CALL	\$53.95

PILLOW SPEAKER PARTS

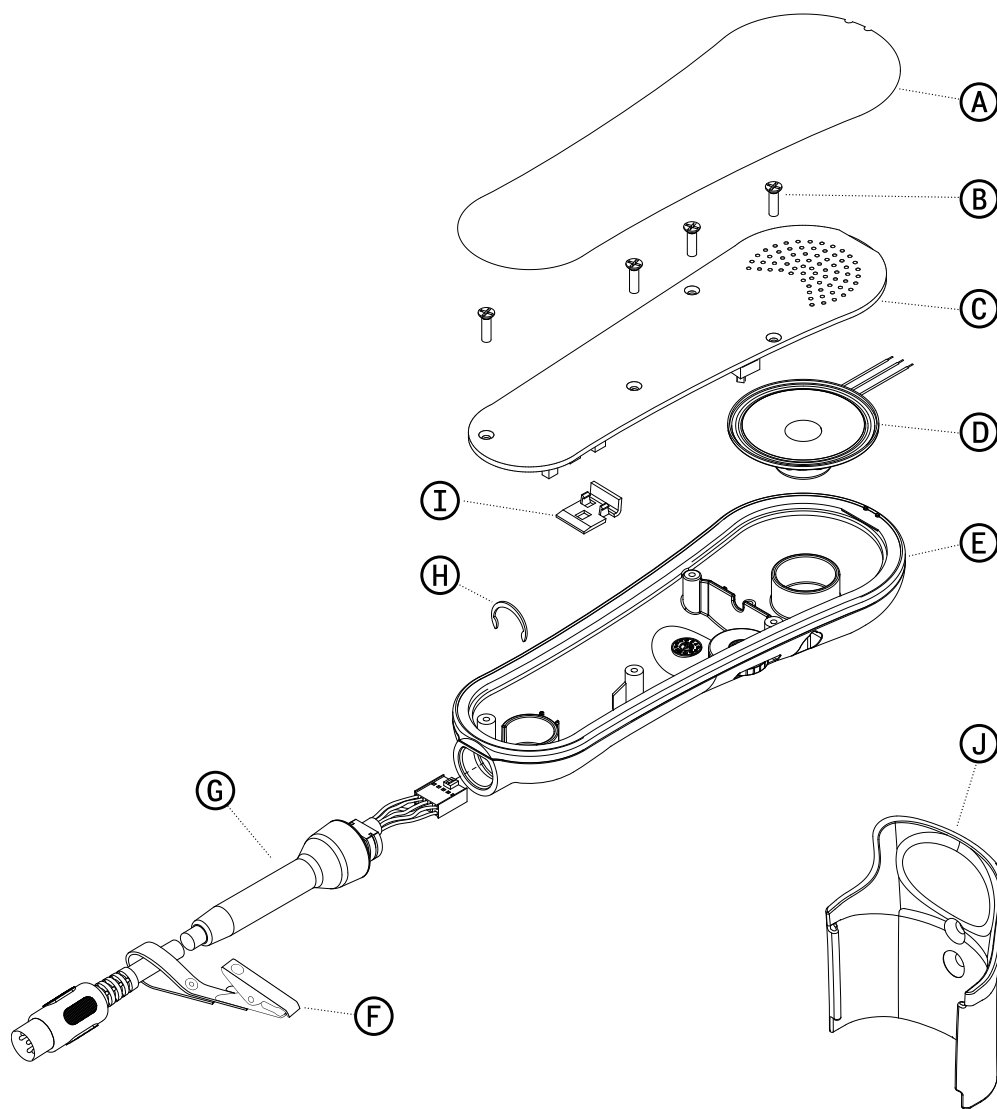

DIAGRAM	MODEL #	PART #	DESCRIPTION	PRICE
A	OLY-G4D	CALL	Overlay for Gen4 Digital and DirectAccess	CALL
A	OLY-G4I	CALL	Overlay for Gen4 Interactive	CALL
B	HDW-1018-001	7490	Case/Board Screws	\$0.10
C	K4D-PCB	CALL	PC Board kit for DPS, Configured (Speaker, Overlay, Switches, Optional Volume Control)	CALL
C	K4C-PCB	CALL	PC Board kit for DirectAccess, Configured (Speaker, Overlay, Switches, Optional Volume Control)	CALL
D	SPR-1000-600	13624	Speaker, 40 Ohm	\$10.25
E	CBK-4000	CALL	Case for Units with Digital Volume Control (blue or gray)	\$8.05
E	CBK-4000	CALL	Case for Units with Digital Volume Control and Headphone Option (blue or gray)	\$8.05
E	CBK-4000	CALL	Case for Units with Analog Volume Control (blue or gray)	\$9.05
E	CBK-4000	CALL	Case for Units with Analog Volume Control and Headphone Option (blue or gray)	\$9.05
F	FA-135	7333	Linen Clip, locking snap	\$1.25
G	CAD-G4-8	CALL	Replacement Cable, Configured, Strain	CALL
H	MSC-1028-010	9556	C Clips, Bag of 10	\$1.95
I	MSC-4020-002	9595	Header Lock, 10-Pin	\$0.50
I	MSC-4020-003	9596	Header Lock, 24-Pin	\$0.50
J	MSC-4023-001	9598	Pillow Speaker Holder	\$8.95



OTHER PRODUCT LINES



PATIENT MONITORING

- ▶ Reusable ECG Cables
- ▶ Reusable ECG Lead Wires
- ▶ Disposable ECG Lead Wires
- ▶ Reusable and Disposable SPO₂ Probes
- ▶ SPO₂ Cables
- ▶ Cable Management

FALL MANAGEMENT

- ▶ Chair and Bed Sensors
- ▶ Sensor Pads
- ▶ Seat Belt Sensors
- ▶ Floor Mat Sensors
- ▶ Floor Cushions and Sensors



CALL CURBELL
TOLL-FREE AT
1-800-235-7500

ORDERING AND WARRANTY INFORMATION

PLACING ORDERS

Orders may be subject to a minimum order requirement. Part numbers, product availability, and pricing are subject to change without notice.

VIA PHONE

Call Curbell toll-free anywhere in the US or Canada at 1-800-235-7500. Outside of the US, call 1-716-667-2520.

VIA FAX

Fax us at 716-667-7775

E-MAIL

We want to hear from you. Contact us with your comments and suggestions at info@curbellmedical.com

PAYMENT TERMS

- Net 30 days terms are extended to established accounts
- Payment with order: send check or money order.
Please call our toll-free number for the exact shipping charge
- COD: Pay the full amount including shipping upon receipt
- Visa, MasterCard, Discover, and American Express are gladly accepted
- Shipping and handling charges will be added to every order

SELLER'S LIMITED WARRANTY

Unless otherwise stated in the limited warranty contained in literature that is shipped with the product (in which case the product literature limited warranty will in all respects apply), the Seller warrants the Buyer that the products will be free from defects in workmanship and materials under normal use for the period of two years from the date of the applicable invoice for pillow speakers and a period of one year from the date of the applicable invoice for all other products and repair services. Repair of pillow speakers is under a 90-day limited warranty against defects in materials and workmanship.

HOW TO RETURN MERCHANDISE

All returns must be processed within 60 days of delivery date and are subject to a 25% restocking fee. Product must be in new, resalable condition, and in the original packaging. Custom-made items are non-returnable. Contact Customer Service at 1-800-235-7500 and ask for a return merchandise authorization number (RMA#). Enclose this RMA# with the item, print the RMA# on the outside of the package, and mail it to:

Curbell Medical Products, Inc.
20 Centre Drive
Orchard Park, NY 14127



Curbell Medical Products, Inc.
7 Cobham Drive
Orchard Park, NY 14127
1-800-235-7500 • Fax 716-667-7775
e-mail: info@curbellmedical.com

OUR VALUES

Curbell takes pride in fostering a culture where people are treated with respect and are encouraged to grow. We believe that in order for Curbell to prosper, it is essential to live by a core set of values.

As our business grows and diversifies, adhering to our core values will serve to ensure that what we stand for remains intact.

Integrity is choosing to act in the best interest of the company and our customers over individual needs.

Respect is treating others in ways that inspire them.

Learning is the continuous testing of experiences, and the transformation of those experiences into knowledge that provides competitive advantage.

These values guide every interaction with our customers and partners, and are a big part of the reason why so many of them have continued to count on Curbell for over 60 years.



INTEGRITY



RESPECT



LEARNING